



landscapeforms®

# STRATA Beam Planning Guide

**The STRATA Beam** expansion opens up a new realm of possibility for the popular line of benches and tables designed by Jess Sorel. It creates a new opportunity for designers to achieve the scalability, elegance and creative freedom of custom, one-off site furnishings with added value and simplicity.

The expansion builds on STRATA Beam’s dramatic, modern aesthetics to offer virtually limitless options and arrangements, allowing it to adapt to a diverse array of landscapes, applications and use cases. This guide offers inspiration on how STRATA Beam can be configured to meet the needs of nearly any site, from quaint courtyards and pocket-parks to high-traffic campuses, streetscapes, and transit centers.

STRATA Beam benches can come together in a range of configurations using Meldstone ultra-high performance concrete (UHPC) bridge legs and three different angle connectors in 90°, 60° and 45°. Possible configurations for STRATA Beam include: U-benches and L-benches; crosses and T-benches; enclosed squares, hexagons and octagons; winding symmetric and asymmetric runs; and mixed arrangements combining connected STRATA Beam benches with singular STRATA Beam benches and tables. Like other 80” STRATA Beam benches, the STRATA Beam expansion benches can be specified backed or backless and with any combination of end and intermediate arms.

The following examples demonstrate the different ways in which STRATA Beam can be specified and the mechanics of how the modular components work together. This guide is by no means exhaustive, but rather a jumping off point intended to familiarize designers with STRATA Beam benches and inspire the many new possibilities this innovative, modular system offers.

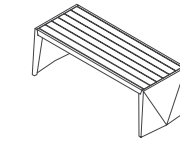

Table  
37" x 87" x 31"

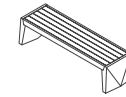
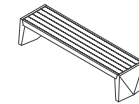

Table-Length  
21" x 69" x 23"



Short Table-Length  
21" x 31" x 23"



Backless  
21" x 80" x 23"

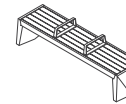

Backless  
Intermediate Arms  
21" x 80" x 23"

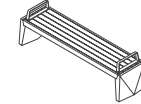

Backless End Arms  
21" x 80" x 23"

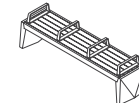

Backless End,  
Intermediate Arms  
21" x 80" x 23"

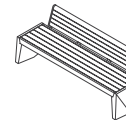

Backed  
24 1/2" x 80" x 31"

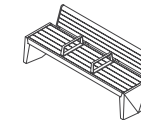

Backed  
Intermediate Arms  
24 1/2" x 80" x 31"



Backed End Arms  
24 1/2" x 80" x 31"



Backed End,  
Intermediate Arms  
24 1/2" x 80" x 31"



Bridge Leg  
21 1/4" x 9 1/4" x 17"

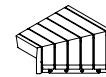

45° Angle Connector  
27" x 24 1/2" x 3 1/4"



60° Angle Connector  
27 3/4" x 25 1/2" x 3 1/4"



90° Angle Connector  
26 3/4" x 26 3/4" x 3 1/4"

**Components**

(2) 80" Backed Bench

(2) 80" Backless Bench

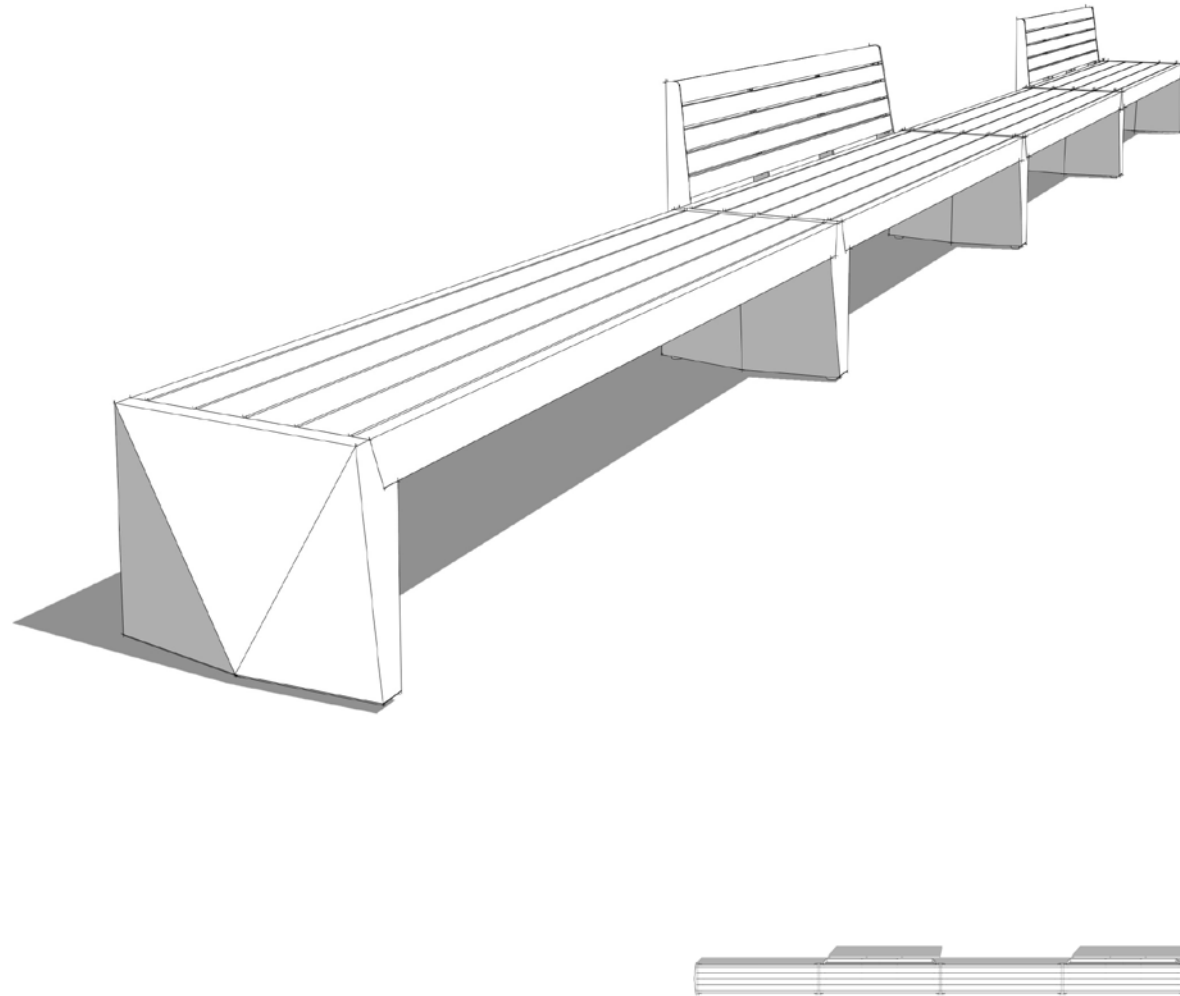

## Components

(1) 80" Backed Bench

(2) 80" Backless Bench

(1) 80" Backless Bench with End Arms

(1) 90° Angle Connector

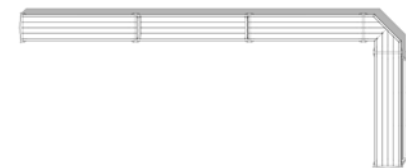
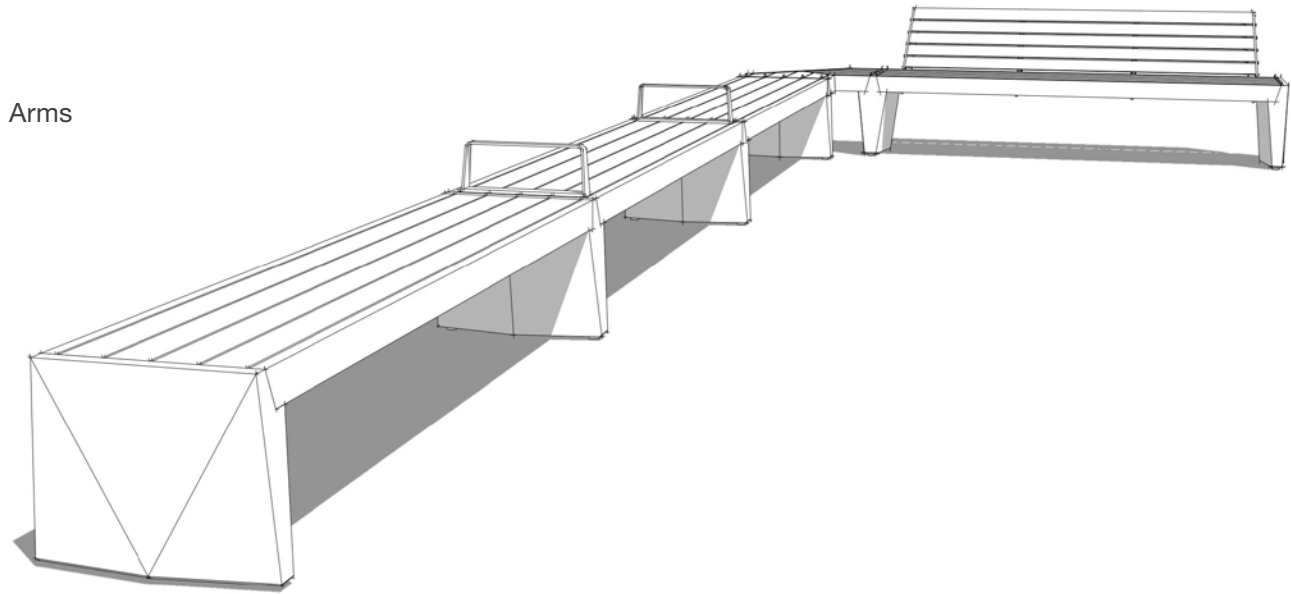

## Components

- (2) 80" Backed Bench
- (3) 80" Backless Bench
- (2) 90° Angle Connector

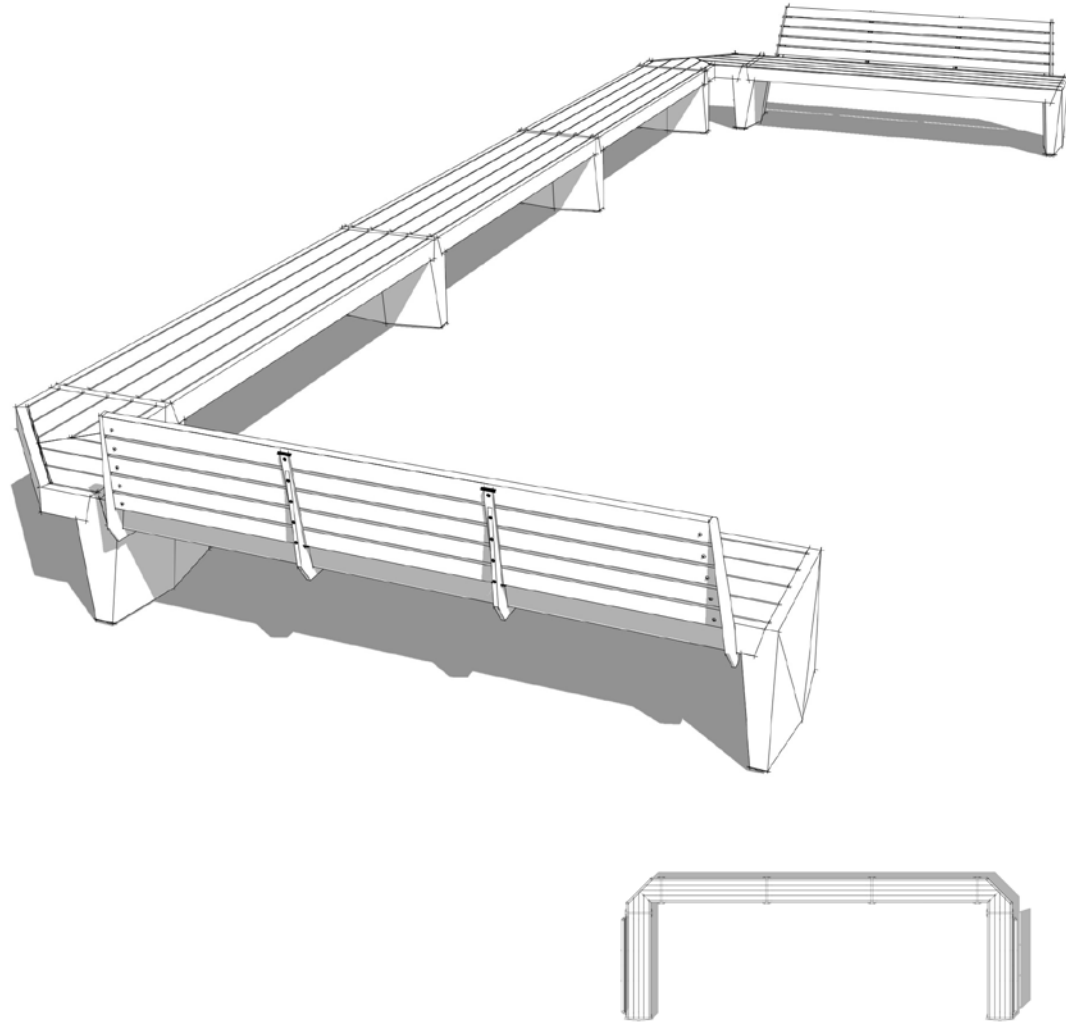

## Components

(2) 80" Backless Bench

(2) 80" Backless Bench with End Arms

(2) 90° Angle Connector

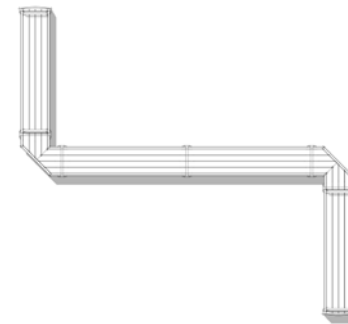
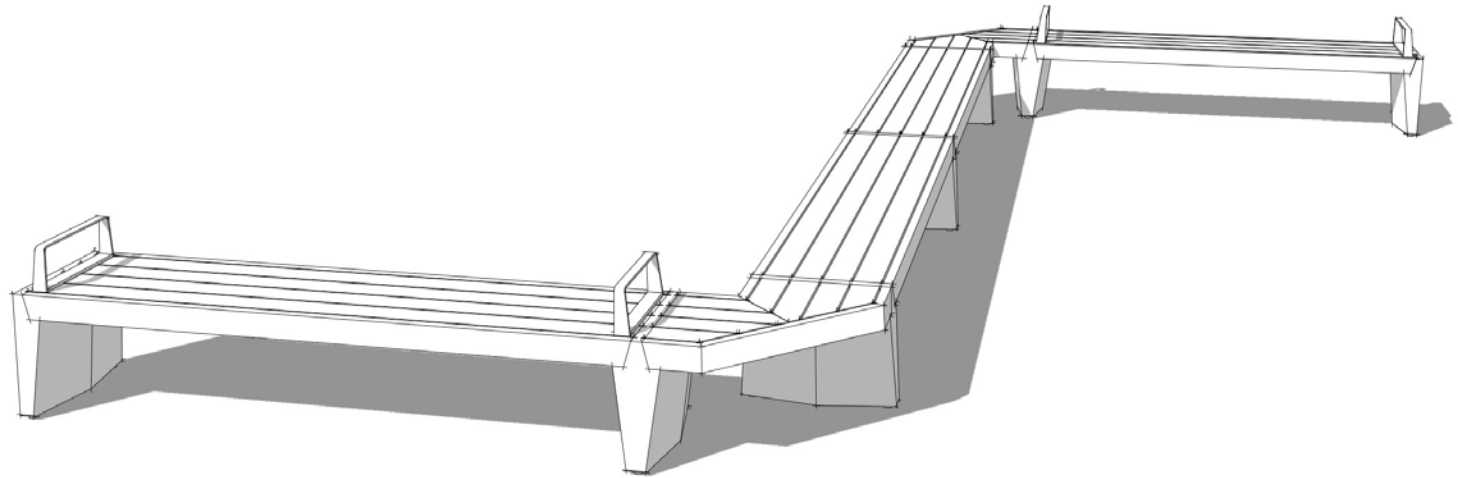

**Components**

**(2)** 80" Backless Bench

**(2)** 80" Backless Bench with End Arms

**(1)** 90° Angle Connector

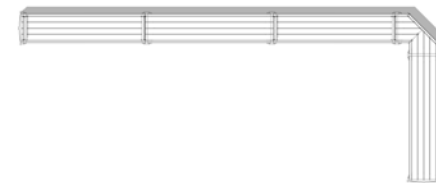
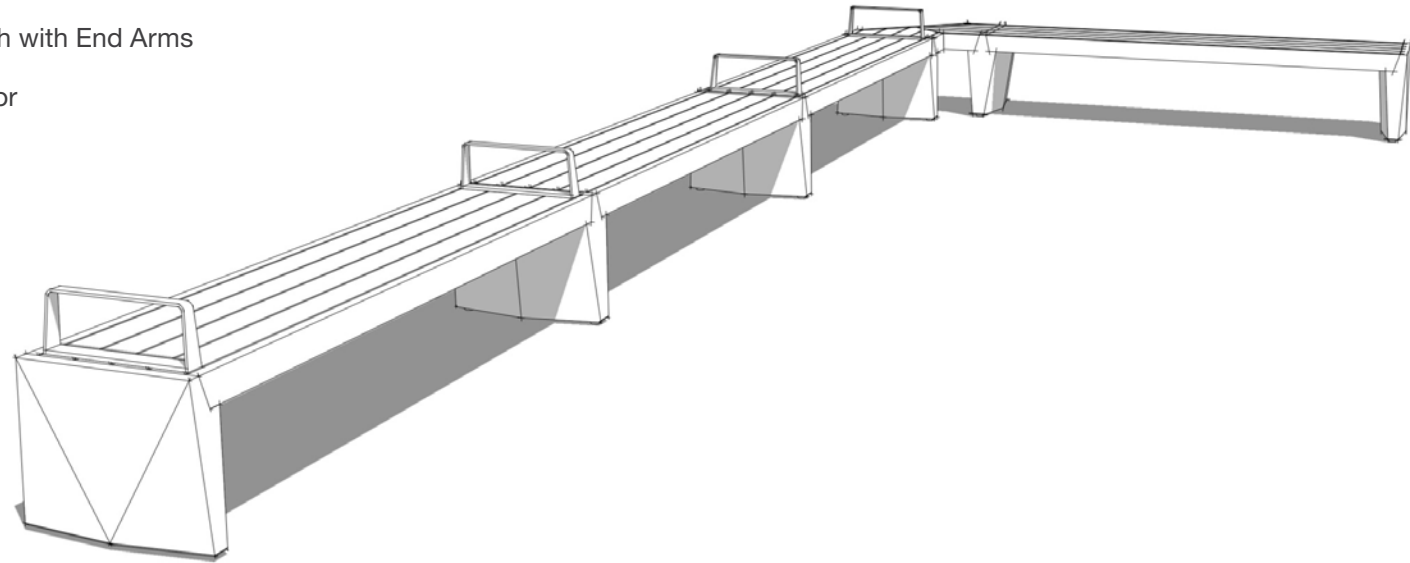

**Components**

(5) 80" Backless Bench

(4) 45° Angle Connector

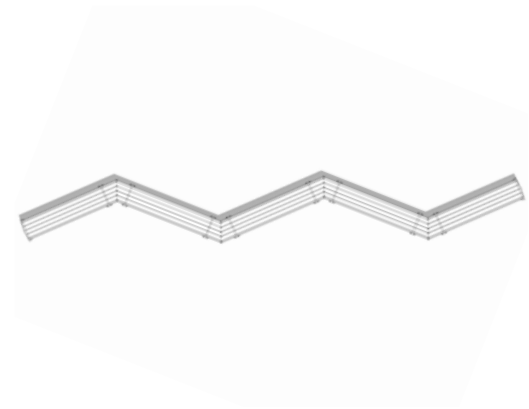
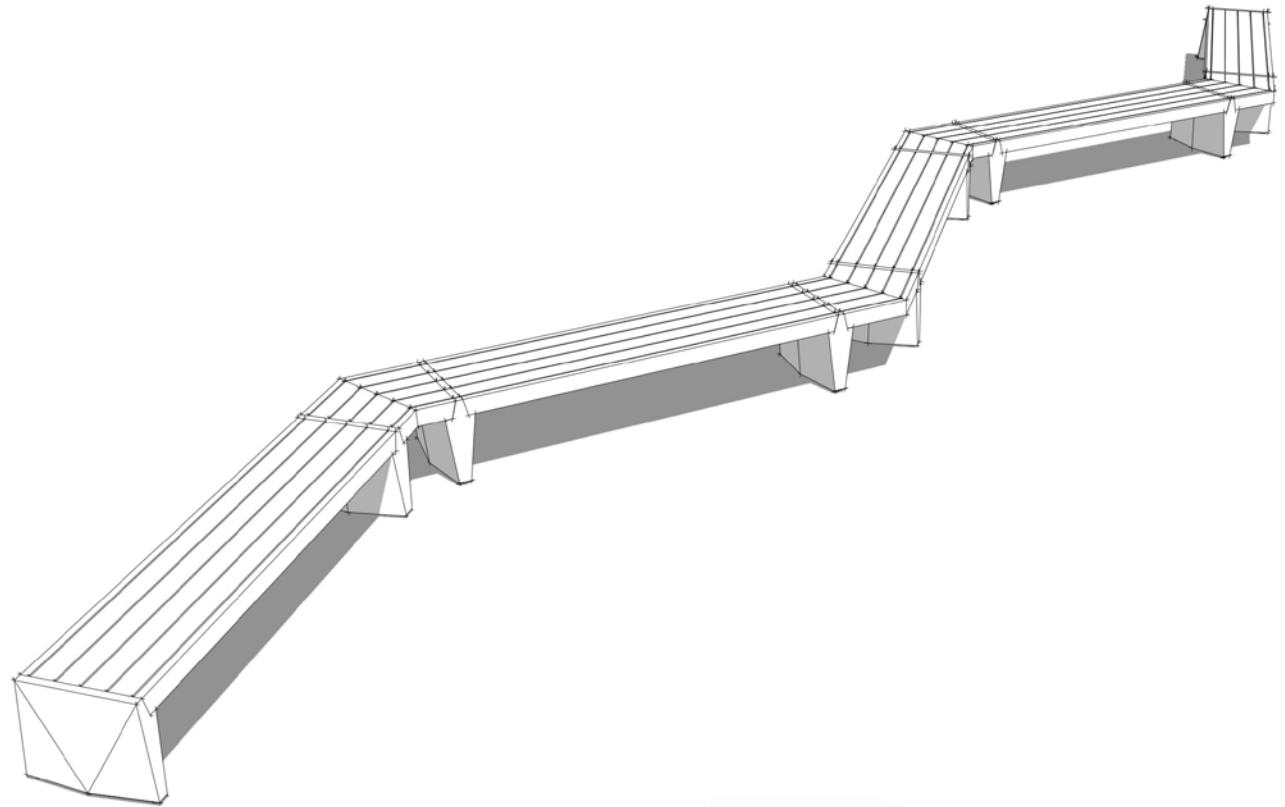



## Components

(3) 80" Backless Bench with End Arms

(2) 90° Angle Connector

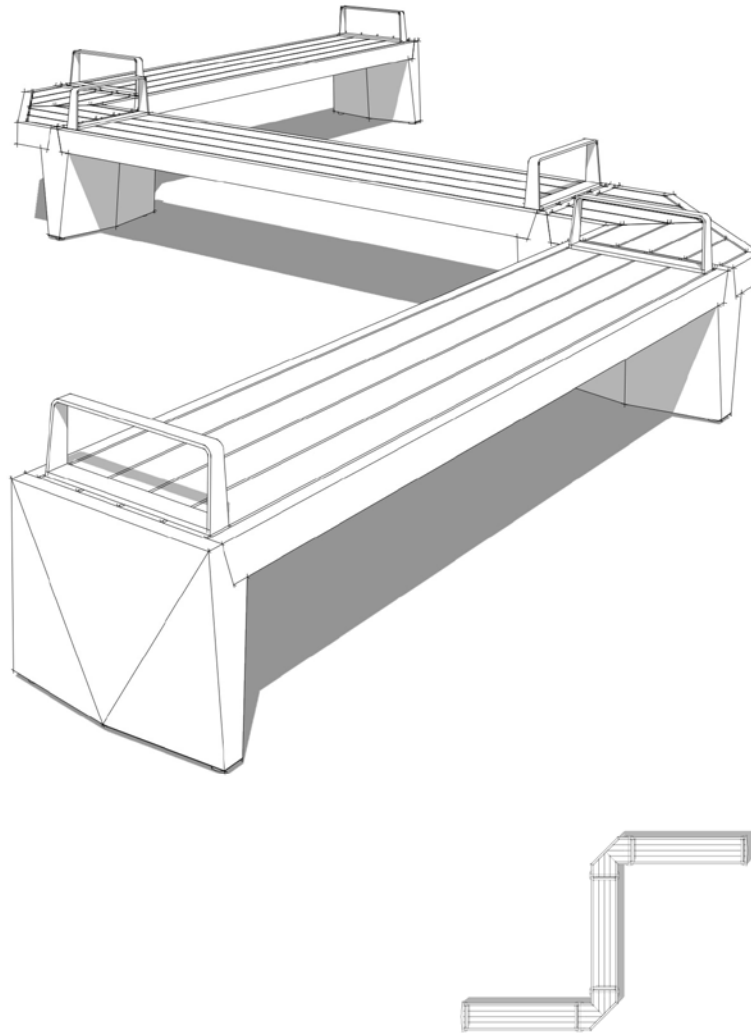

## Components

(2) 80" Backed Bench, Single

(4) 80" Backless Bench

(2) 90° Angle Connector

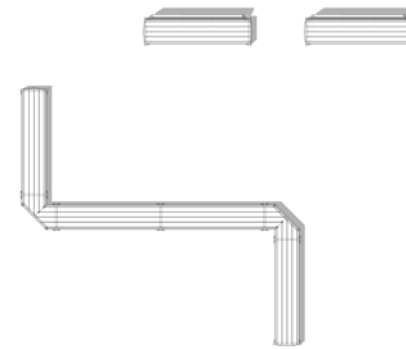
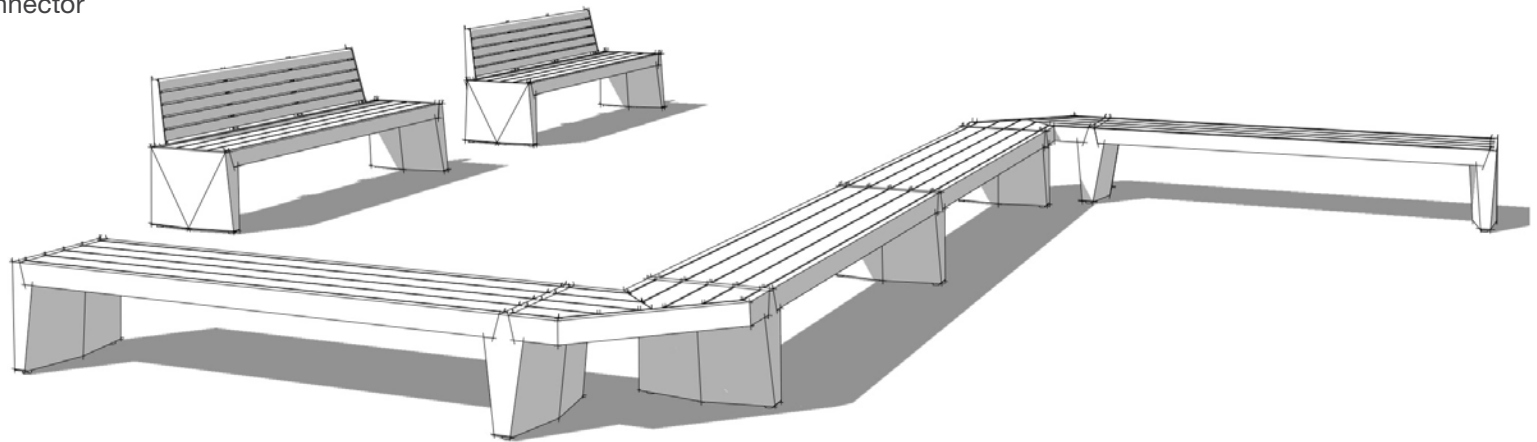

## Components

### Right Configuration

(2) 80" Backed Bench

(1) 90° Angle Connector

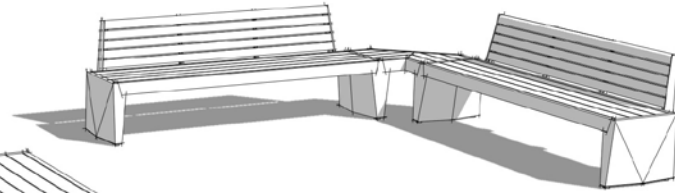

### Left Configuration

(2) Configurations of:

(2) 80" Backless Bench

(1) 90° Angle Connector

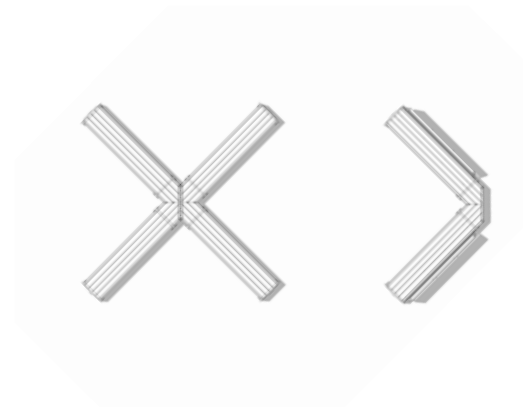
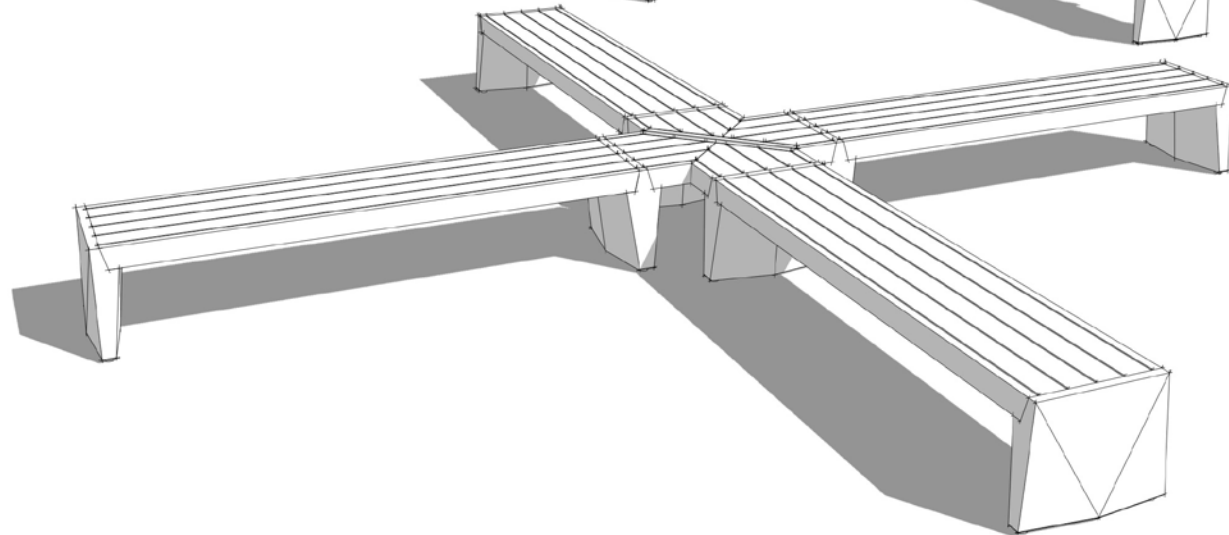

## Components

(2) 69" Backless Bench

(1) 80" Backless Bench

(2) 45° Angle Connector

(2) Table

(4) 31" Bench, Single

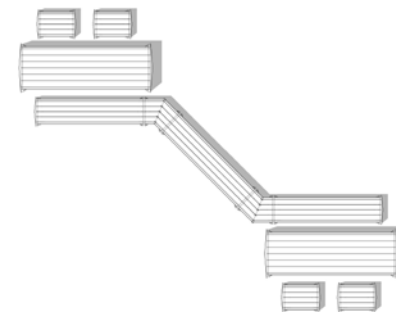
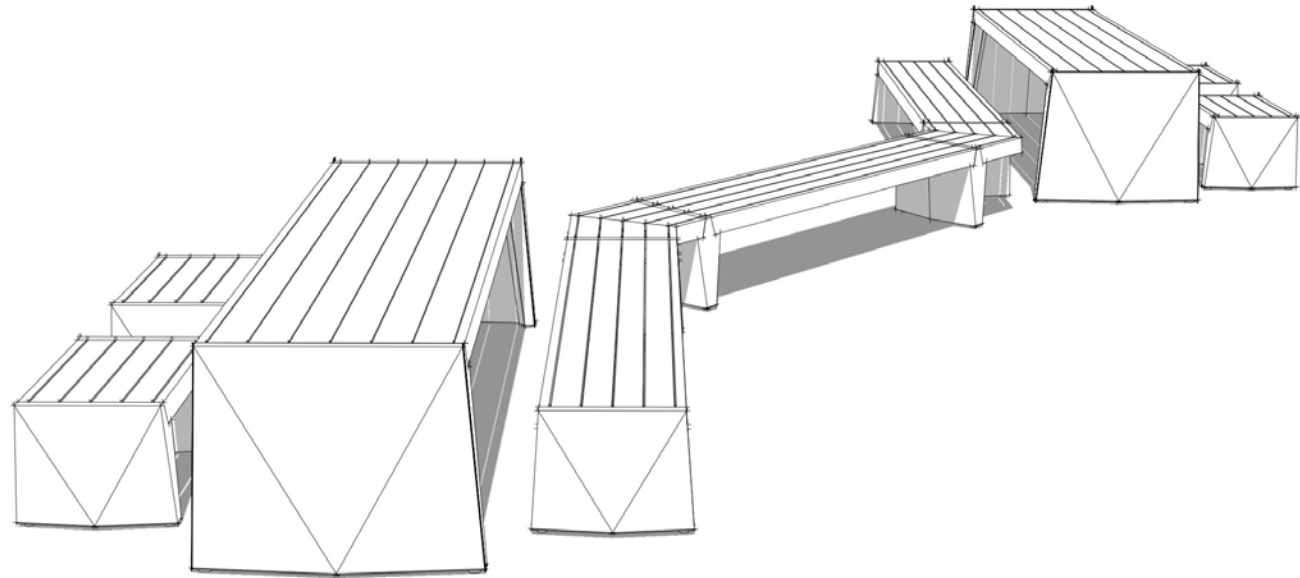

## Components

- (3) 80" Backed Bench
- (1) 80" Backless Bench
- (3) 60° Angle Connector

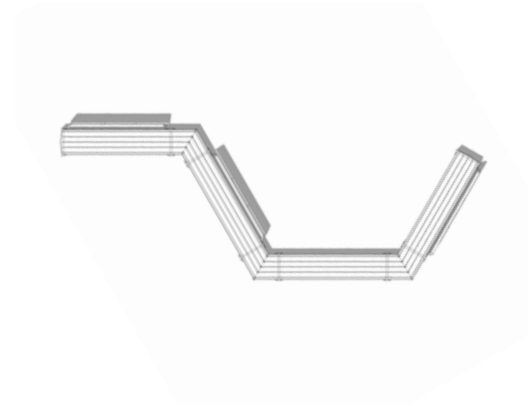
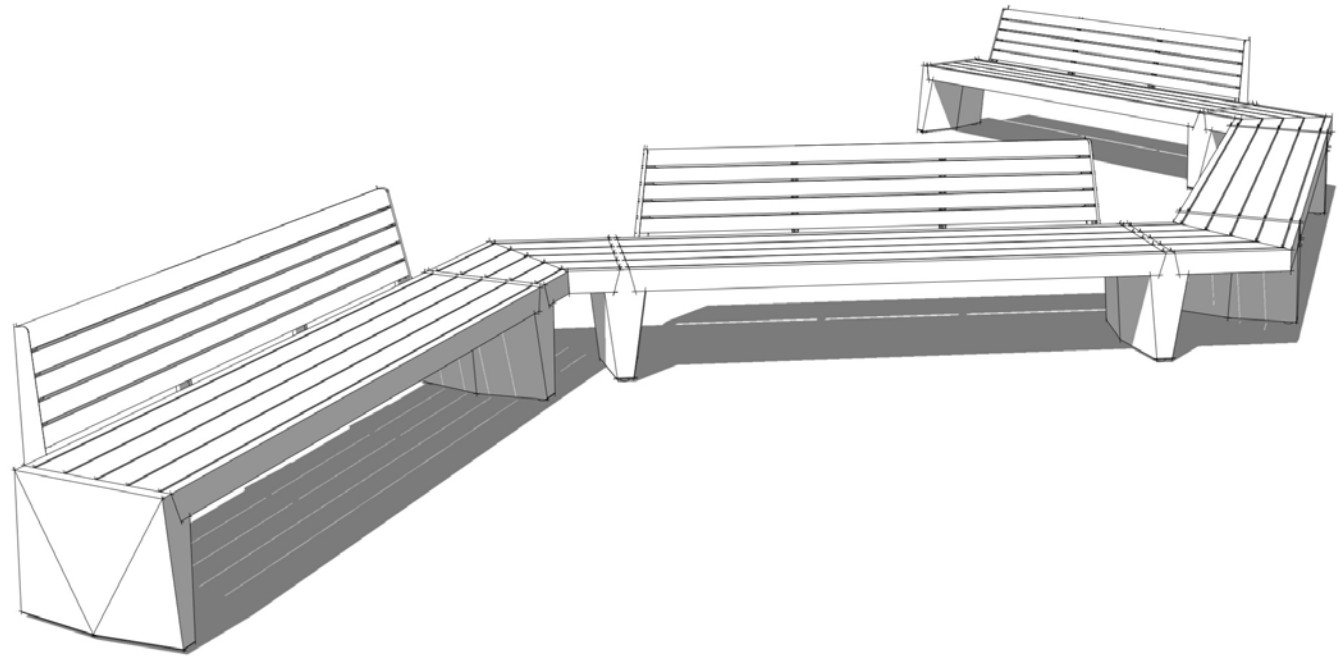

## Components

- (3) 80" Backed Bench
- (2) 80" Backless Bench
- (4) 60° Angle Connector

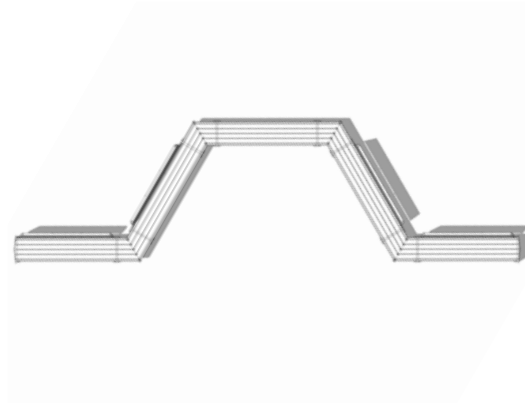
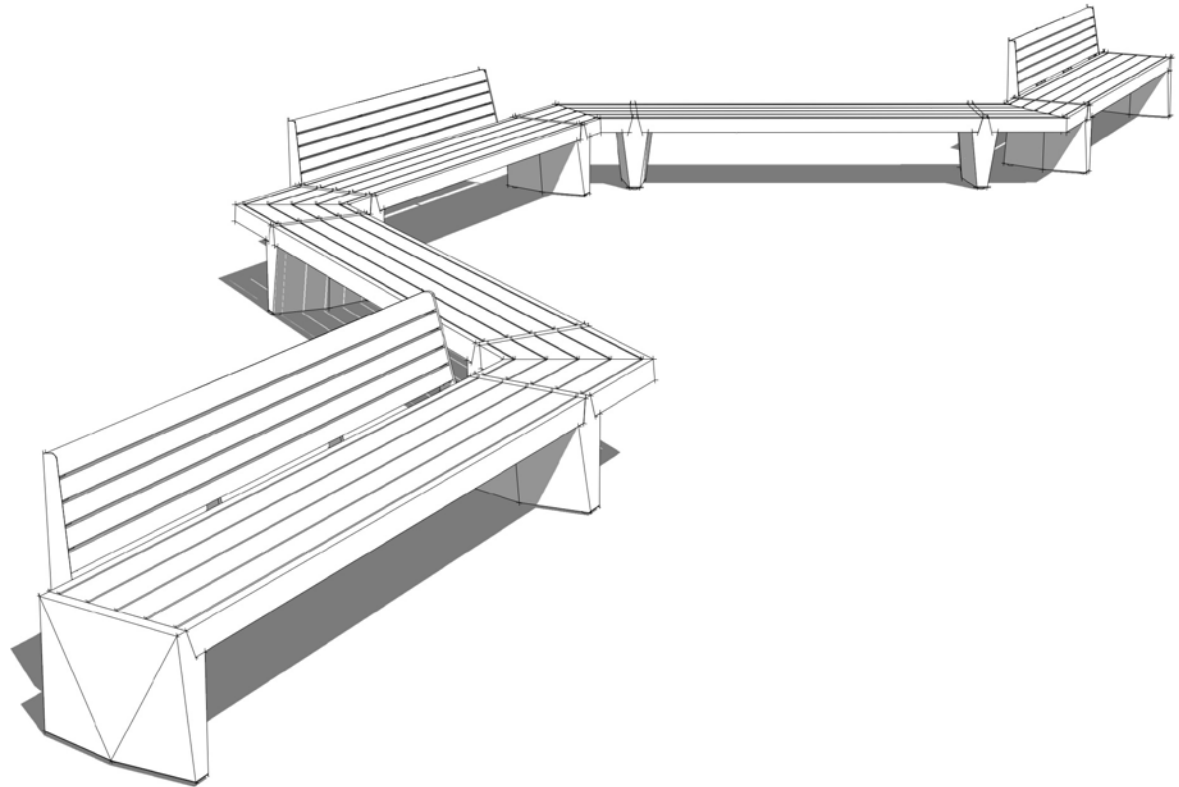

## Components

- (3) 80" Backed Bench
- (1) 80" Backless Bench
- (3) 60° Angle Connector

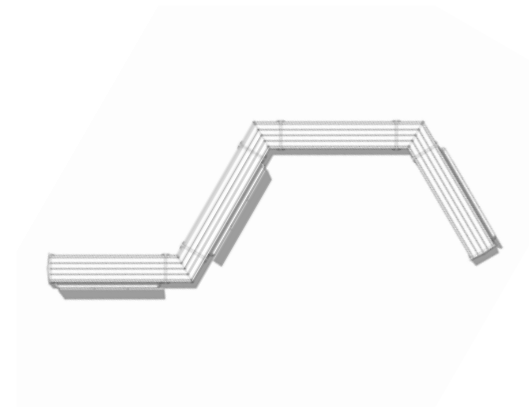
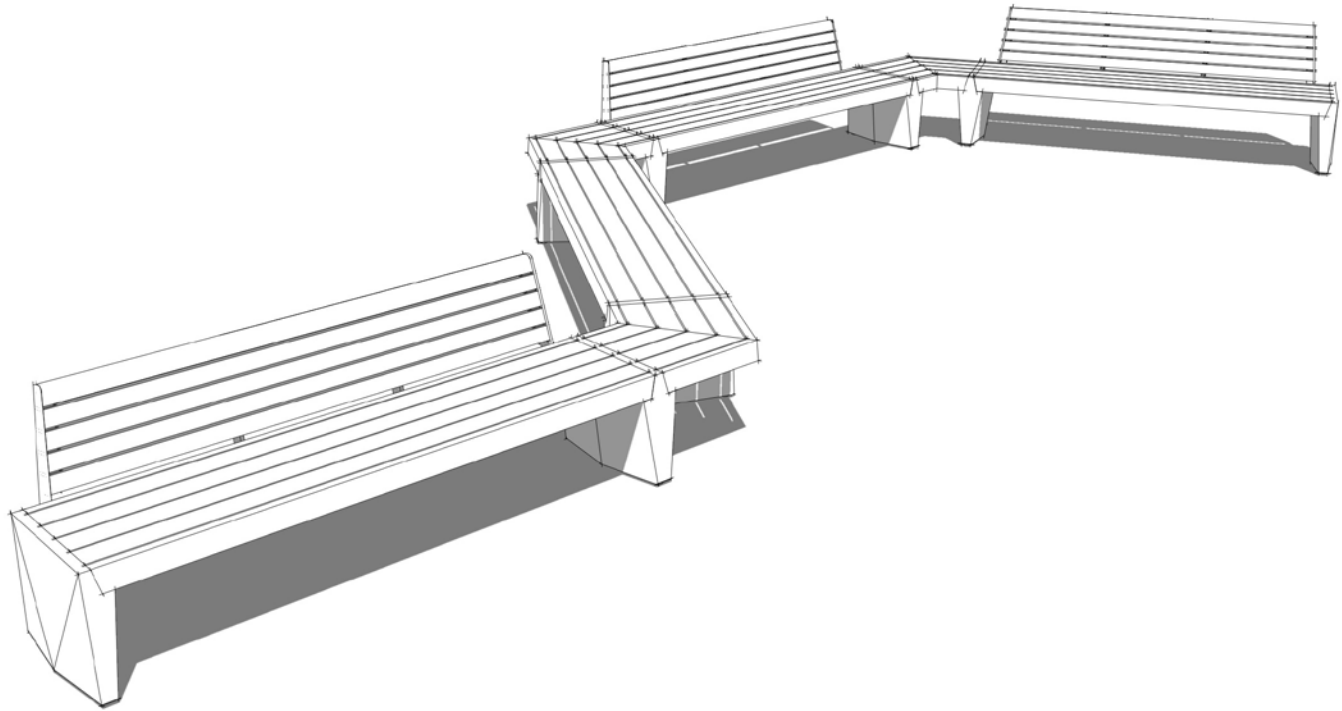

## Components

- (2) 80" Backed Bench
- (2) 80" Backless Bench
- (2) 90° Angle Connector

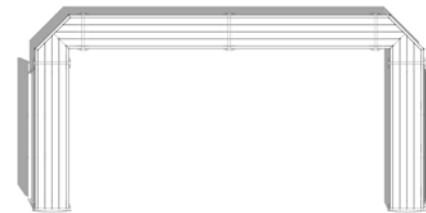
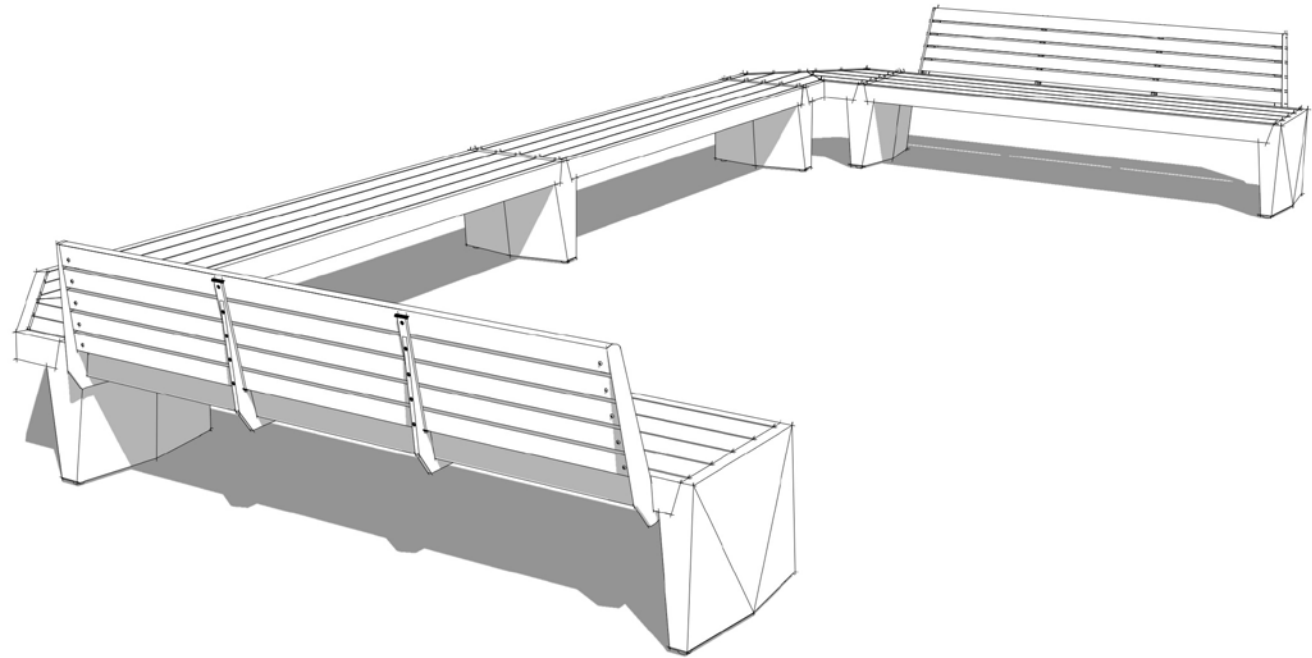



**Components**

- (2) 80" Backed Bench
- (2) 80" Backless Bench
- (2) 60° Angle Connector

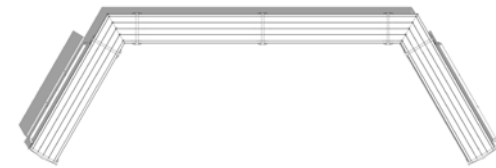
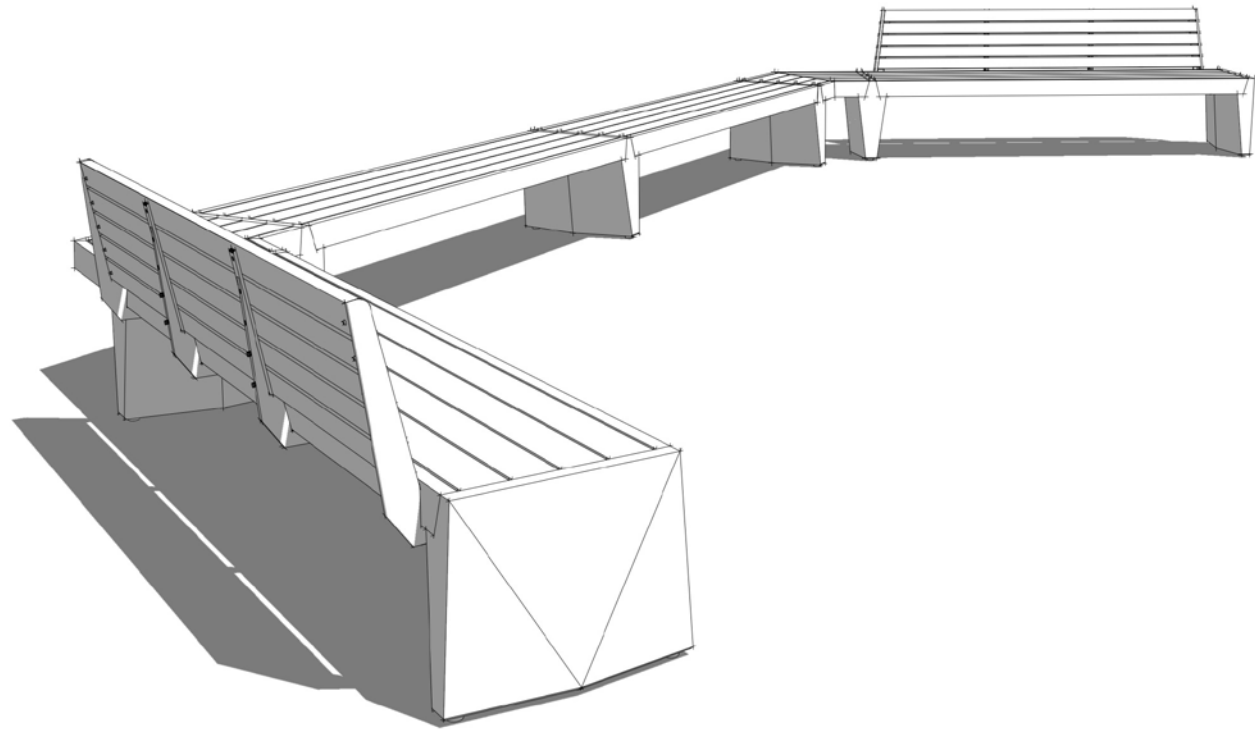

**Components**

**(3)** 80" Backed Bench

**(2)** 60° Angle Connector

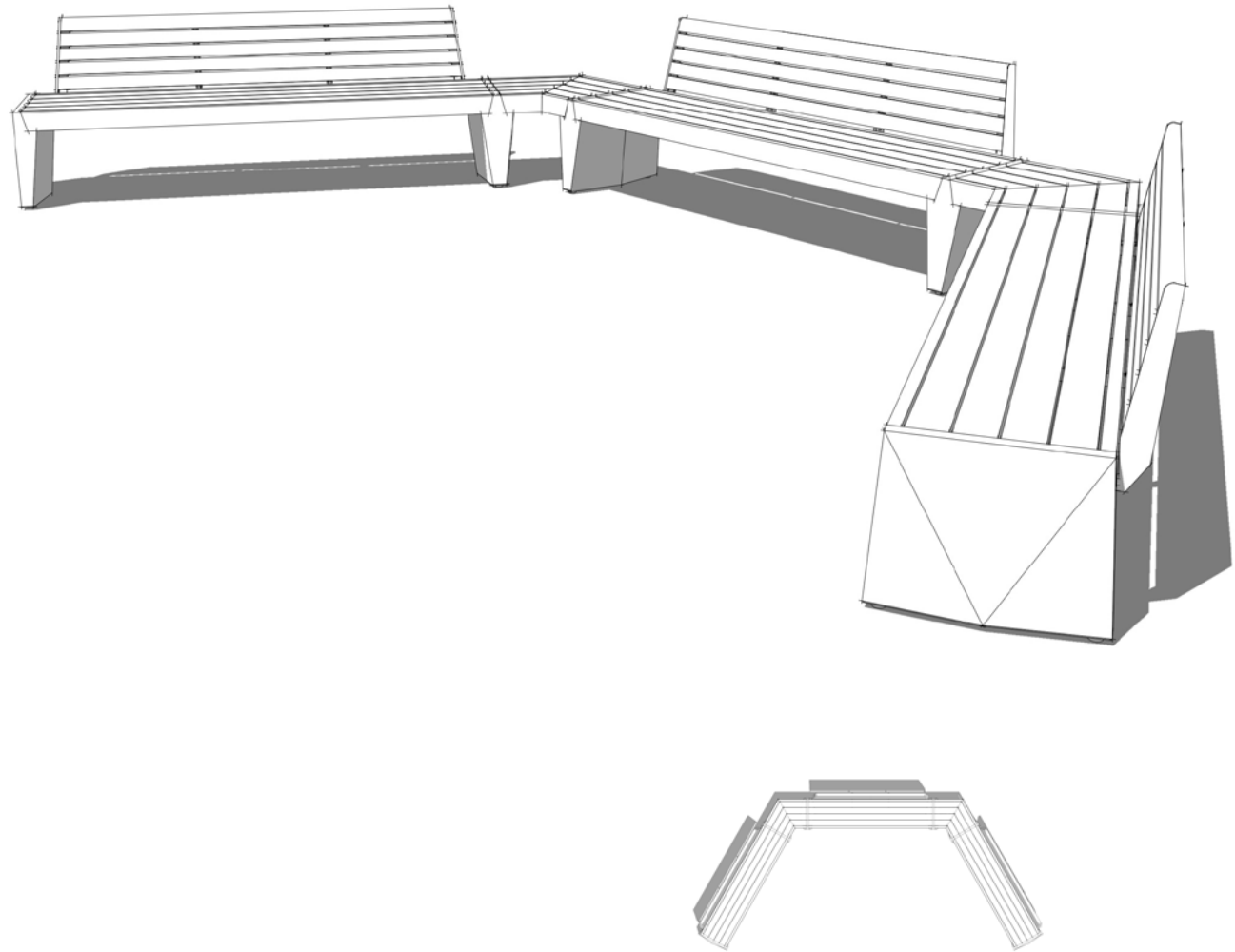

**Components**

(6) 80" Backless Bench

(6) 60° Angle Connector

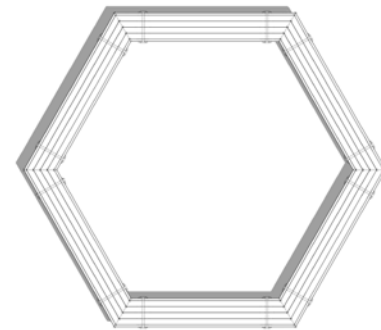
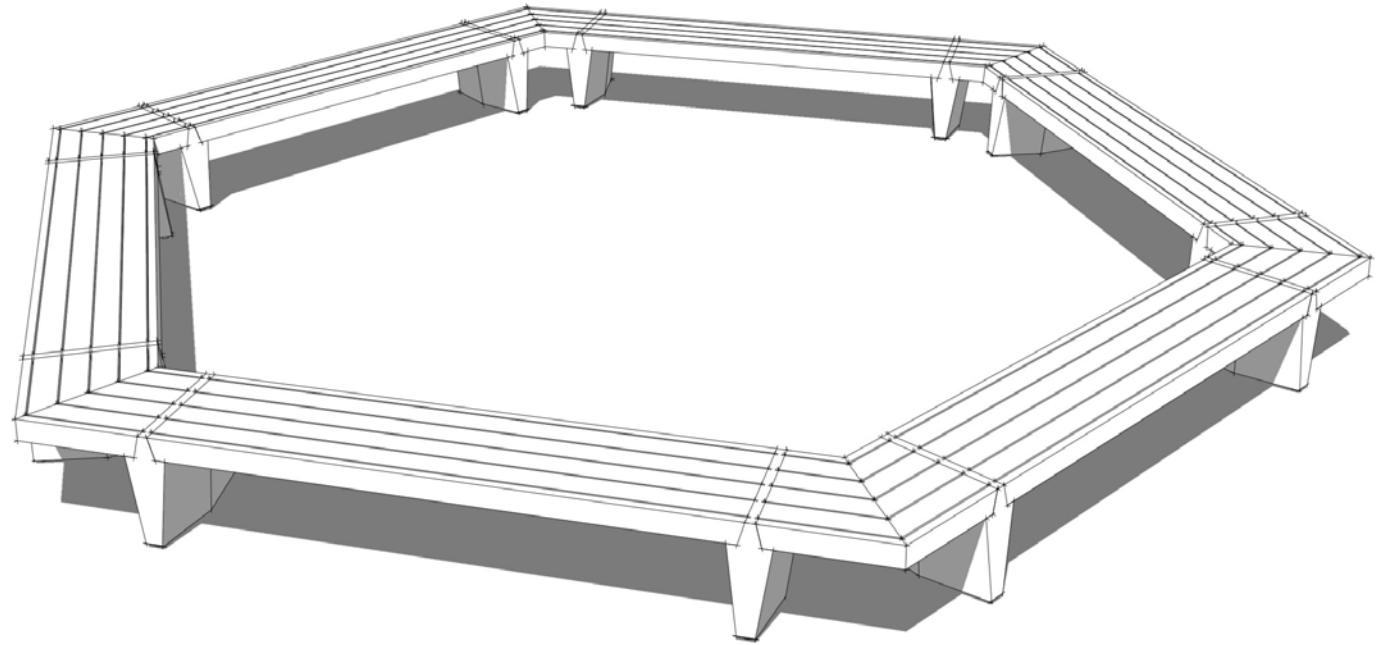

[landscapeforms.com](https://landscapeforms.com)

STRATA Beam Bench:  
Design by Jess Sorel

Specifications are subject  
to change without notice.  
Landscape Forms supports  
the Landscape Architecture  
Foundation at the Second  
Century level. ©2022  
Landscape Forms, Inc.

landscapeforms®

