

 **AEROLYZE**

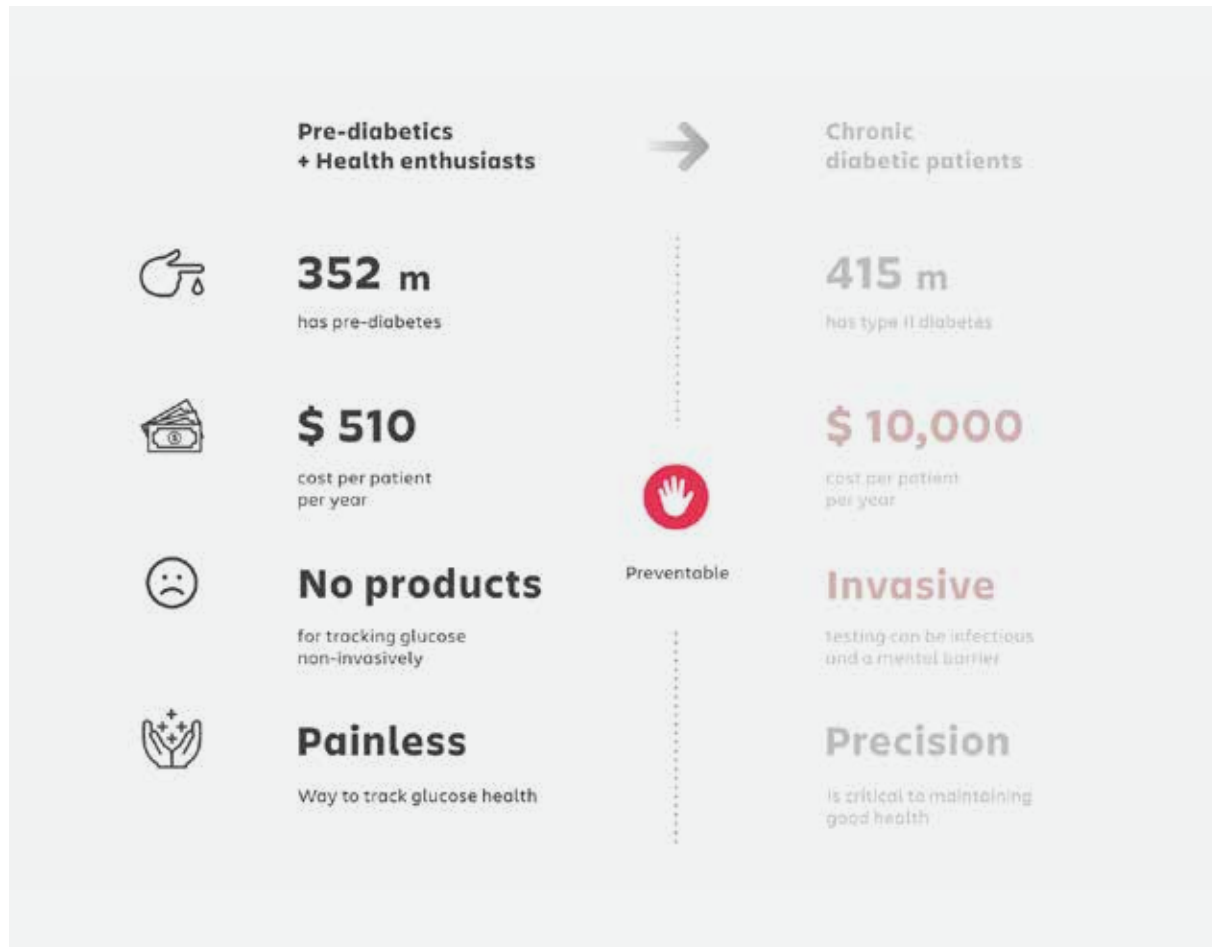

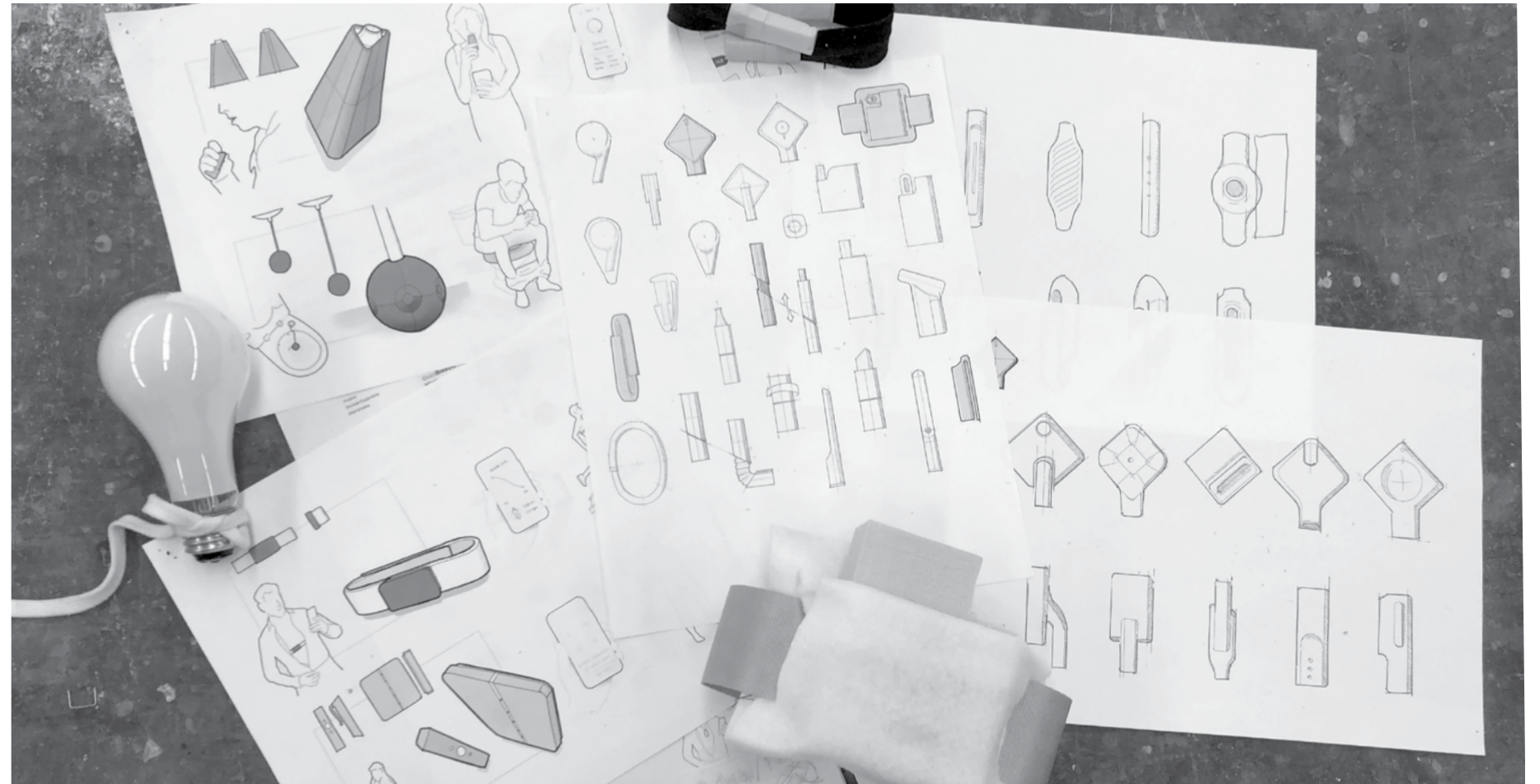

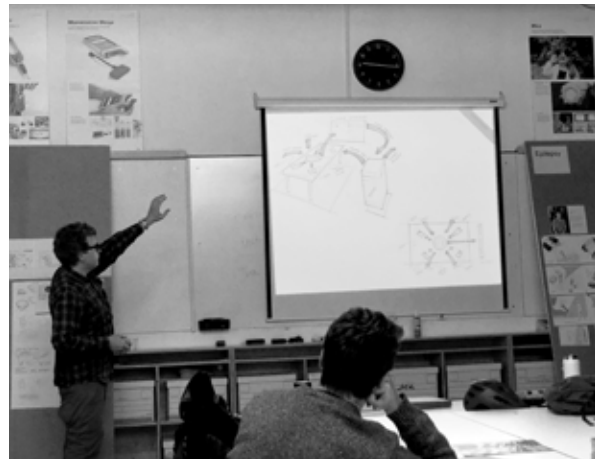

RESEARCH & IDEATION

SPECTROSCOPY



ELECTRICAL CONDUCTIVITY

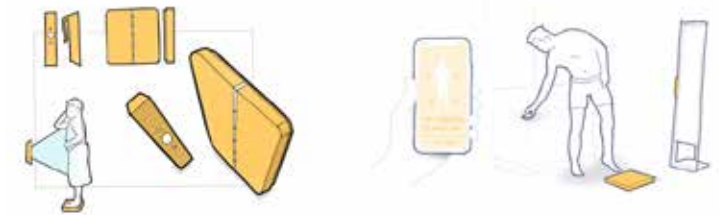

BREATH ANALYSIS

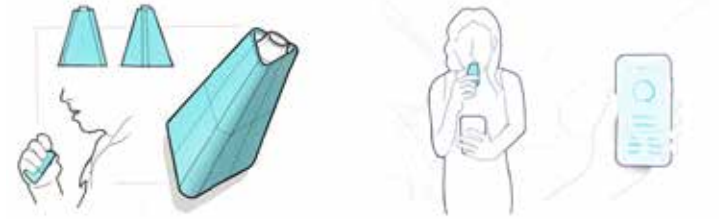

URINALYSIS



DIET

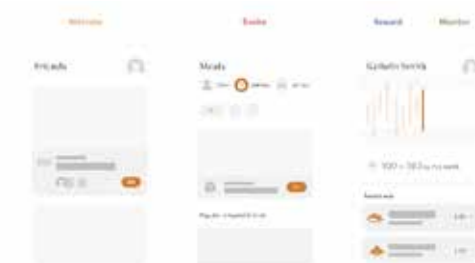

MEDICAL

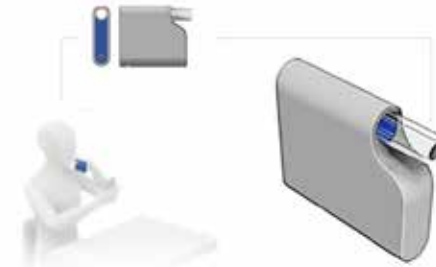

EXERCISE



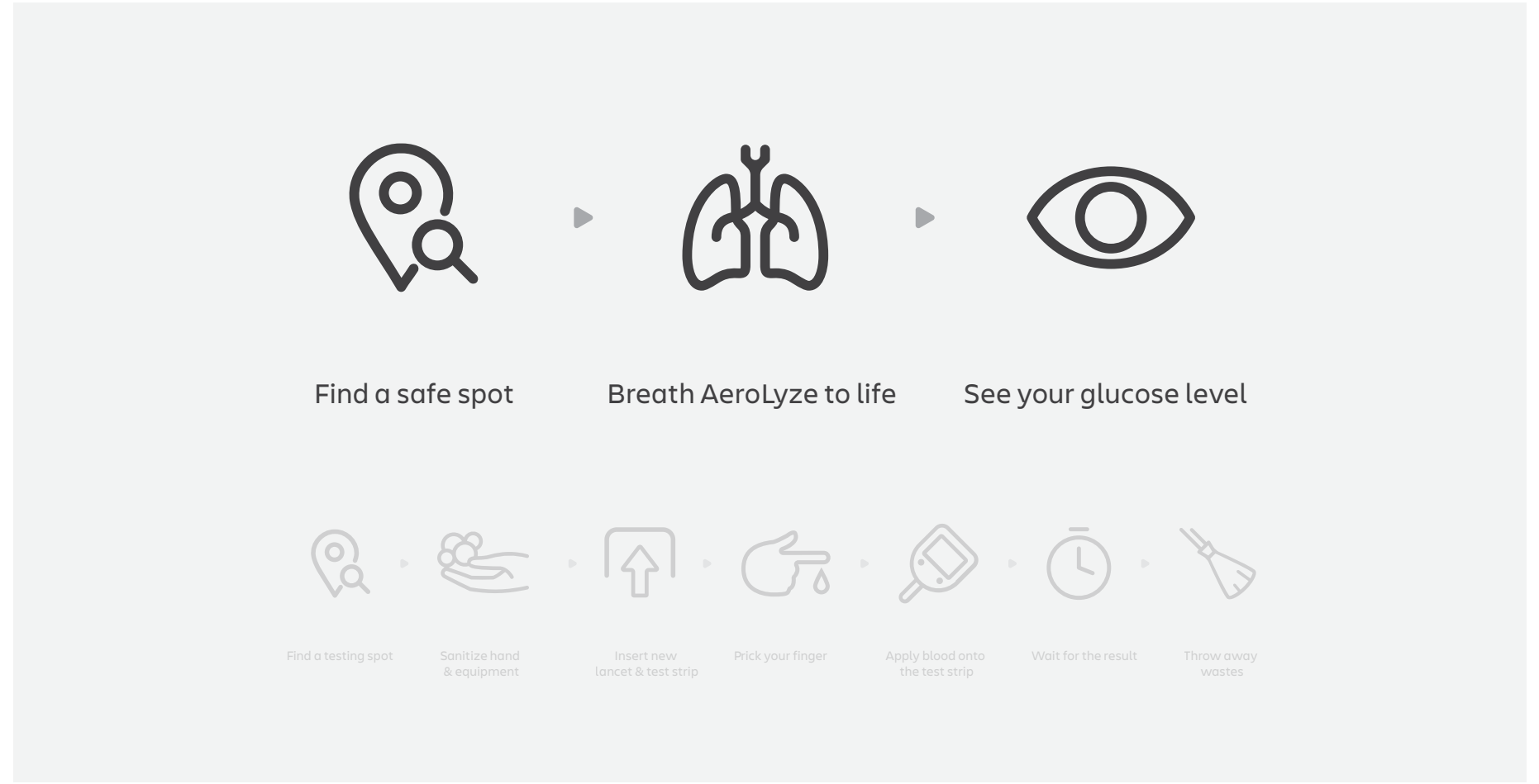

STREAMLINING THE USER EXPERIENCE.

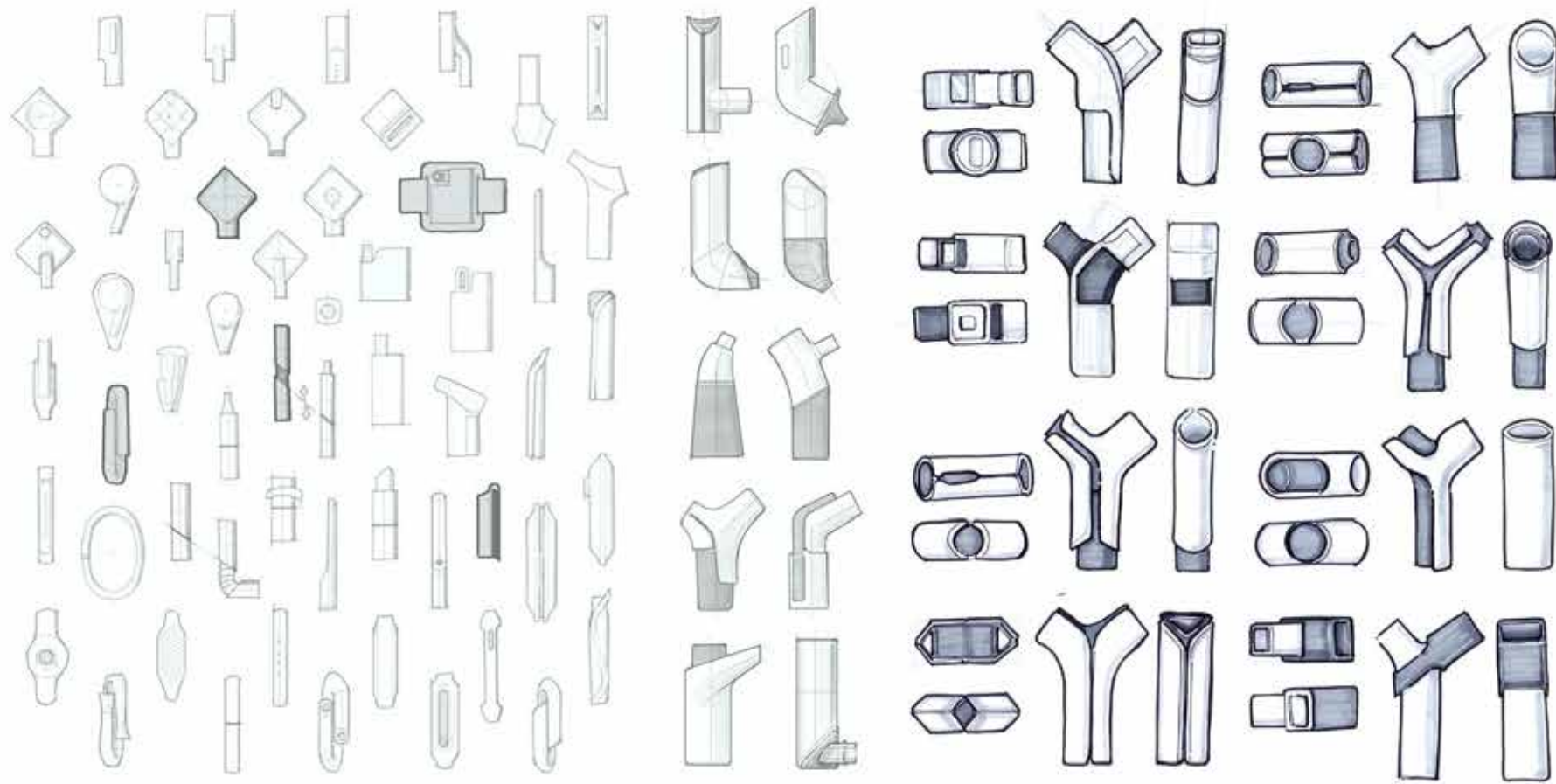

A FORM THAT IS NEITHER A VAPE OR A NEBULIZER.



USER TESTING

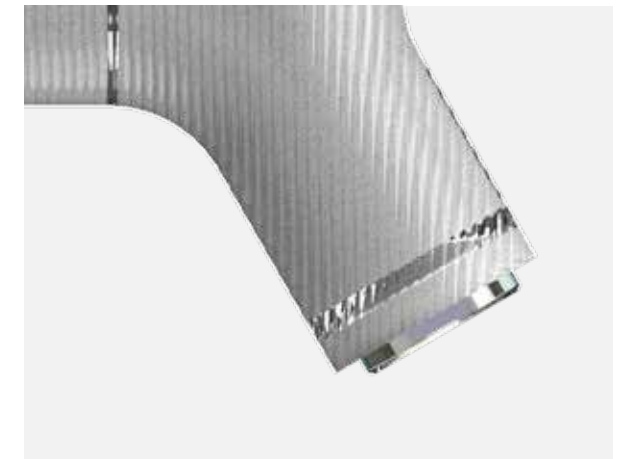
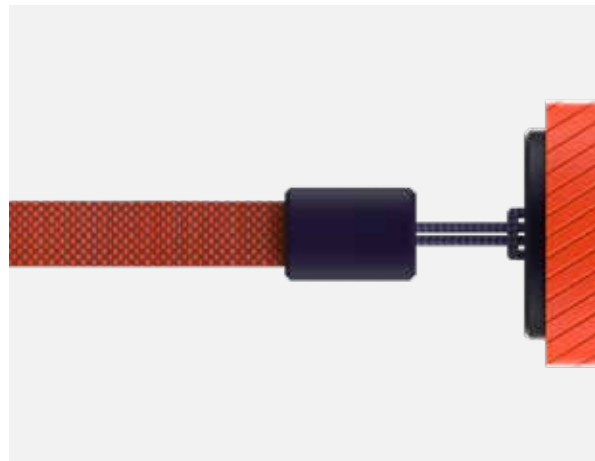

BALANCING LIFESTYLE AND MEDICAL AESTHETICS.



Glucose breath analyzer
for **pre-diabetics**.



Type II

Medical grade,
market glucose meters



Ketosis

breath
analyzer

Alcohol

breath
analyzer

No More waste
No Visible blood
No Risk of infection
No Subscription
No Test strips

No More pain

No More hiding away
No Sharp needles
No Training
No Expiration date
No Alcohol pads



GLUCOSE LEVEL



LOW



GOOD



HIGH

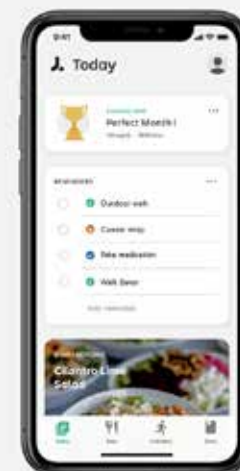

VARYING LEVEL OF INFORMATION FOR DIFFERENT CONTEXTS



CHECK YOUR BLOOD GLUCOSE LEVELS ANYWHERE.

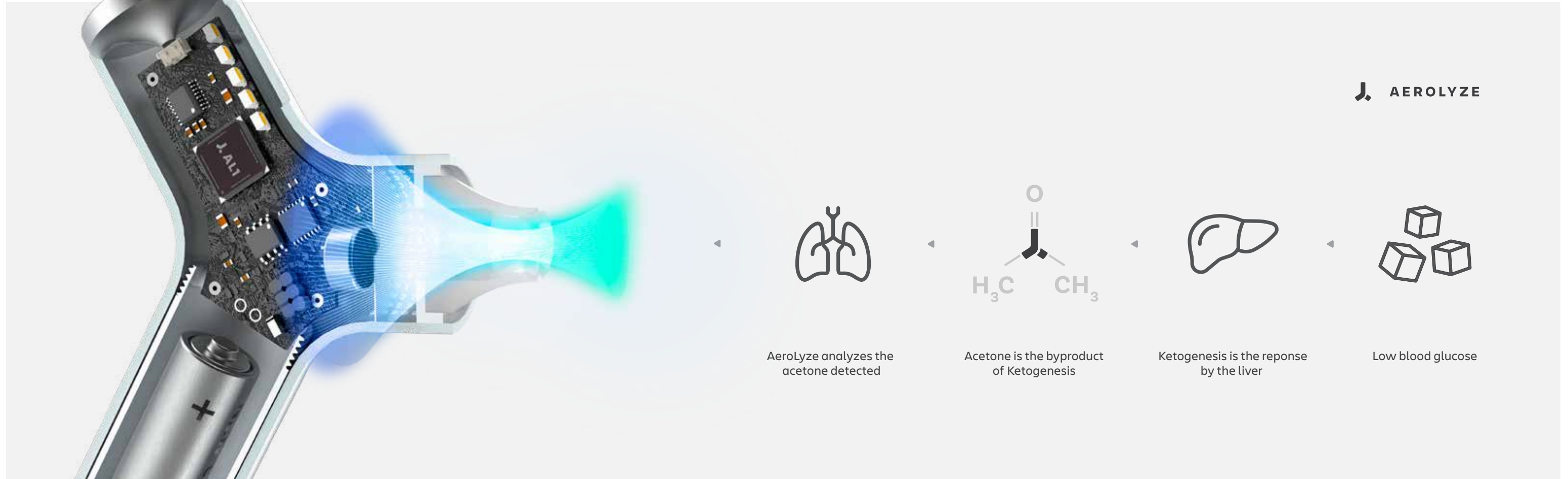

THE HIGHER THE GLUCOSE, THE LOWER THE ACETONE DETECTED.

- 1 MEDICAL GRADE POLYETHYLENE ENCLOSURE
- 2 ALUMINUM BATTERY CASE
- 3 REMOVABLE MOUTH TIP
- 4 AL1 COMPUTE BOARD
- 5 SALIVA FILTER

