



BuzziMood

Product Specification Sheet

This document contains technical information about the BuzziMood







www.buzzi.space

Lift up your mood

Let your imagination run wild and create your own graphic wall art. BuzziMood is an acoustical wall solution that offers the possibility to combine materials found in nature with upholstered pads in a range of different fabrics and geometrical shapes. This blend mitigates noise and serves as a natural air humidity indicator too when mixed with moss panels. Choose between two moss colors, a light and dark green, to create varying degrees of contrast against the metal frames. As the name suggest, this acoustic solution will undoubtedly lift up your mood in any setting.

Design by Cory Grosser

General

-  BuzziMood Round | Square D | Square Leaf | Rectangular D | Rectangular Leaf | Zig | Zag
Wall mounted
-  Frame: powder coated metal in Black (RAL 9005) or Fluo Yellow (RAL 1016)
Back: MDF
-  Dry use
-  Assembled

Acoustics



Absorption



Diffusion



Content

Configurations	3
Moss	5
Fabrics	5
Fixing System	9
Dimensions	10
Acoustics	13

Configurations

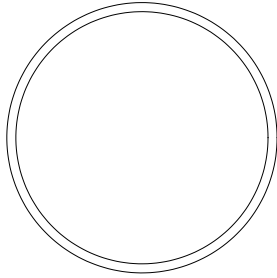

BuzziMood Round



-  Filling: Reindeer moss or acoustic foam
Frame: powder coated metal in Black (RAL 9005) or Fluo Yellow (RAL 1016)
Back: MDF
-  Ø 60 cm H 7,5 cm
Ø 23.62" H 2.95"
-  Upholstered: 4,9 kg | 10.80 lbs
Moss: 5,2 kg | 11.46 lbs

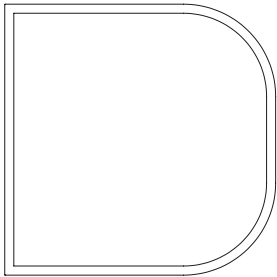

BuzziMood Square D



-  Filling: Reindeer moss or acoustic foam
Frame: powder coated metal in Black (RAL 9005) or Fluo Yellow (RAL 1016)
Back: MDF
-  W 60 cm D 60 cm H 7,5 cm
W 23.62" D 23.62" H 2.95"
-  Upholstered: 5,6 kg | 12.35 lbs
Moss: 6,2 kg | 13.67 lbs

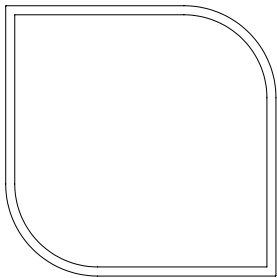

BuzziMood Square Leaf

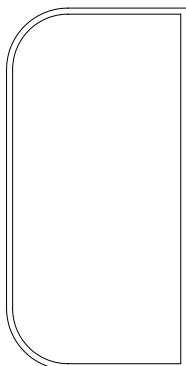

-  Filling: Reindeer moss or acoustic foam
Frame: powder coated metal in Black (RAL 9005) or Fluo Yellow (RAL 1016)
Back: MDF
-  W 60 cm D 60 cm H 7,5 cm
W 23.62" D 23.62" H 2.95"
-  Upholstered: 5,6 kg | 12.35 lbs
Moss: 6,2 kg | 13.67 lbs

BuzziMood Rectangular D



-  Filling: Reindeer moss or acoustic foam
Frame: powder coated metal in Black (RAL 9005) or Fluo Yellow (RAL 1016)
Back: MDF
-  W 120 cm D 60 cm H 7,5 cm
W 47.24" D 23.62" H 2.95"
-  Upholstered: 10,5 kg | 23.15 lbs
Moss: 11,6 kg | 25.57 lbs

BuzziMood Rectangular Leaf

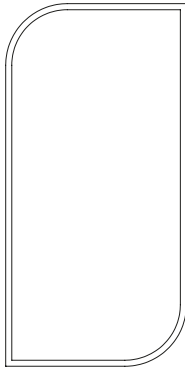

🌲 Filling: Reindeer moss or acoustic foam
Frame: powder coated metal in Black (RAL 9005) or Fluo Yellow (RAL 1016)
Back: MDF

✂ W 120 cm D 60 cm H 7,5 cm
W 47.24" D 23.62" H 2.95"

⚖ Upholstered: 10,5 kg | 23.15 lbs
Moss: 11,6 kg | 25.57 lbs

BuzziMood Zig

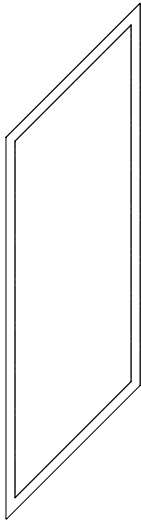

🌲 Filling: Reindeer moss or acoustic foam
Frame: powder coated metal in Black (RAL 9005) or Fluo Yellow (RAL 1016)
Back: MDF

✂ W 114 cm D 30 cm H 7,5 cm
W 44.88" D 11.81" H 2.95"

⚖ Upholstered: 5,5 kg | 12.13 lbs
Moss: 6,1 kg | 13.45 lbs

BuzziMood Zag

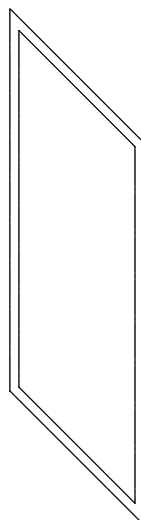

🌲 Filling: Reindeer moss or acoustic foam
Frame: powder coated metal in Black (RAL 9005) or Fluo Yellow (RAL 1016)
Back: MDF

✂ W 114 cm D 30 cm H 7,5 cm
W 44.88" D 11.81" H 2.95"

⚖ Upholstered: 5,5 kg | 12.13 lbs
Moss: 6,1 kg | 13.45 lbs

Moss

Light Green



Dark Green



Fabrics

Fabric

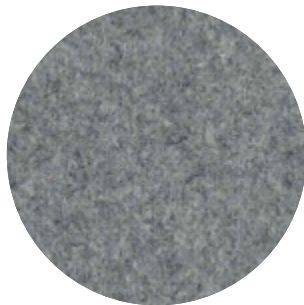

Category A

Composition 70% Recycled Wool, 25% Recycled Polyacryl,
5% Recycled Other Fabrics

Weight 405 g/m² | 11.94 oz/yd²

Abrasion resistance 40.000 Martindale, 50,000 Wyzenbeek

Flammability EU: EN 1021.1/2006 | BS EN 1021.1/2006 (cigarette).
EN 1021.2/2006 | BS EN 1021.2/2006 (match)
USA: CAL TB 117 | ASTM E84 CLASS A

Fastness to light EU: 4 | USA 4

Fastness to rubbing EU: Wet 3-4 | Dry 4-5

Fastness to crocking USA: Wet 5 | Dry 5



Rough

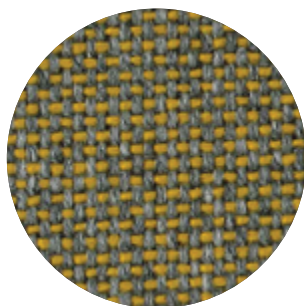

Category A

Composition 100% Polyacryl

Weight 456 g/m² | 13.45 oz/yd²

Abrasion resistance 40.000 Martindale

Flammability EU: EN 1021.1/2006 | BS EN 1021.1/2006 (cigarette)
USA: CAL TB TB 117

Fastness to light EU: 5

Fastness to rubbing EU: Wet: 3 | Dry: 3



Trevira CS+ | CS

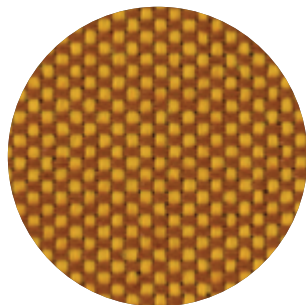

Category A

Weight 420 g/m² | 12.39 oz/yd²

Composition 100% Polyester, Trevira CS

Abrasion resistance 100.000 Martindale, 90,000 Wyzenbeek

Flammability BS 5852 part II: CRIB 5 | BS 7176 Medium Hazard
USA: CAL TB 117 | M1 | B1 | EN 1021/1-2 | C1 |
IMO Res. A652 (16)

Fastness to light EU: 6 | USA 5

Fastness to rubbing EU: Wet 4-5 | Dry 4-5

Fastness to crocking USA: Wet 5 | Dry 5



Revive 1

kvadrat

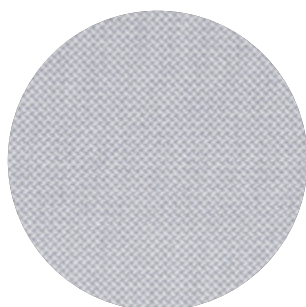

Category A

Composition 100% recycled polyester FR

Weight 430 g/lin.m

Abrasion resistance 60.000 Martindale rubs, EN ISO 12947

Flammability EN 1021-1/2 | DIN 4102 B1 | Önorm B1/Q1
UNI 9175 1IM | US Cal. Tech. Bull. 117
IMO A.652 (16)

Fastness to light Note 5-7, ISO 105-B02

Fastness to rubbing (ISO) dry 5, wet 4-5

Pilling Note 4-5, EN ISO 12945



Revive 2

kvadrat

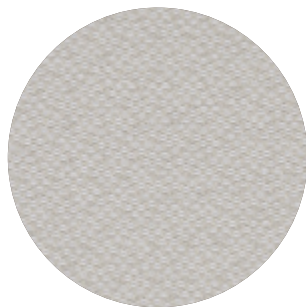

Category A

Composition 100% recycled polyester FR

Weight 420 g/lin.m

Abrasion resistance 45.000 Martindale rubs, EN ISO 12947

Flammability EN 1021-1/2 | DIN 4102 B1 | Önorm B1/Q1
UNI 9175 1IM | US Cal. Tech. Bull. 117
IMO A.652 (16)

Fastness to light Note 5-7, ISO 105-B02

Fastness to rubbing (ISO) dry 5, wet 4-5

Pilling Note 4-5, EN ISO 12945



Terra

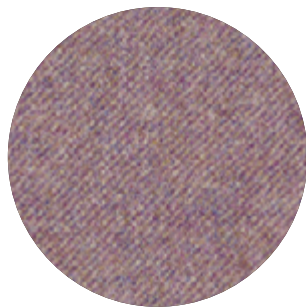

Category B

Composition 100% Pure New Wool

Weight 370 g/m² | 10.91 oz/yd²

Abrasion resistance 40.000 Martindale, 25,000 Wyzenbeek

Flammability EU: BS5852 CRIB 5 | BS5867 PART 2 : 2008 : TYPE B
EN: 1021.2/2006 | USA: CAL TB 117

Fastness to light EU 5 | USA 5

Fastness to rubbing EU: Wet 4 | Dry 4

Fastness to crocking USA: Wet 4 | Dry 4



Clara 2

kvadrat

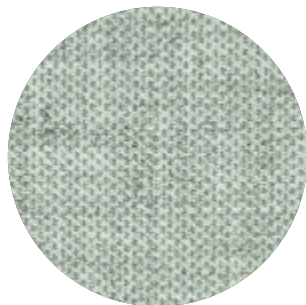

Category B

Composition 92% new wool, 8% nylon

Weight 400 g/lin.m

Abrasion resistance 80.000 Martindale rubs, EN ISO 12947

Flammability EN 1021-1/2 | BS 5852, ignition source 2-3 | DIN 4102 B2
NF D 60 013 | UNI 9175 11M | US Cal. Tech. Bull. 117, Sec. E
NFPA 260 | IMO A.652(16)

Fastness to light Note 5-7, ISO 105-B02

Fastness to rubbing (ISO) dry 4-5, wet 4

Pilling Note 4, EN ISO 12945



Remix 2

kvadrat



Category B

Composition 90% new wool, 10% nylon

Weight 415 g/lin.m

Abrasion resistance 100.000 Martindale rubs, EN ISO 12947

Flammability EN 1021-1/2 | BS 5852 part 1
Önorm B1/Q1 | NF D 60 013 | UNI 9175, 11M
AS/NZS 1530.3 | Cal. Tech. Bull. 117-2013
NFPA 260 | IMO FTP Code 2010:Part 8

Fastness to light Note 5-7, ISO 105-B02

Fastness to rubbing (ISO) dry 4-5, wet 4

Pilling Note 4, EN ISO 12945



Hero

kvadrat

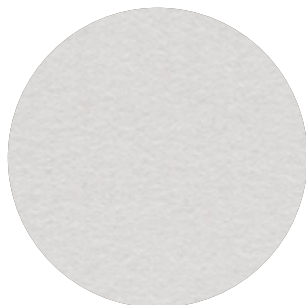

Category C

Composition 96% new wool, 4% nylon

Weight 580 g/lin.m

Abrasion resistance 45.000 Martindale rubs, EN ISO 12947

Flammability EN 1021-1/2 | DIN 4102 B2 | NF D 60 013
UNI 9175 11M | US Cal. Bull. 117-2013 | NFPA 260
IMO A.652 (16)

Fastness to light Note 5-6, ISO 105-B02

Fastness to rubbing (ISO) dry 4-5, wet 4-5

Pilling Note 3-4, EN ISO 12945



Tonus 4

kvadrat



Category D

Composition 90% new wool, 10% Helanca

Weight 665 g/lin.m

Abrasion resistance 100.000 Martindale rubs, EN ISO 12947

Flammability EN 1021-1/2 | BS 5852 part 1 | DIN 4102 B2
Önorm B1/Q1 | NF D 60 013 | UNI 9175 11M
US Cal. Bull. 117-2013 | NFPA 260 | IMO A.652 (16)

Fastness to light Note 5-7, ISO 105-B02

Fastness to rubbing (ISO) dry 3-5, wet 3-5

Pilling Note 3, EN ISO 12945



Tonus Meadow

kvadrat

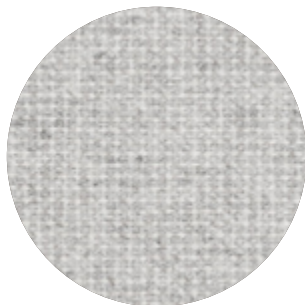

Category D

Composition 90% new wool, 10% Helanca

Weight 665 g/lin.m

Abrasion resistance 100.000 Martindale rubs, EN ISO 12947

Flammability EN 1021-1/2 | BS 5852 part 1 | DIN 4102 B2

Önorm B1/Q1 | NF D 60 013 | UNI 9175 11M

US Cal. Bull. 117-2013 | NFPA 260 | IMO A.652 (16)

Fastness to light Note 5-7, ISO 105-B02

Fastness to rubbing (ISO) dry 4-5, wet 4

Pilling Note 3, EN ISO 12945



Memory 2

kvadrat

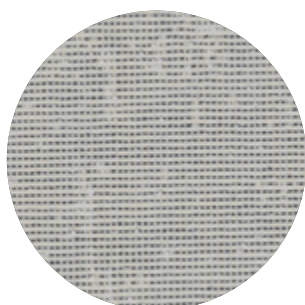

Category E

Composition 100% Trevira CS

Weight 700 g/lin.m

Abrasion resistance

35.000 rubs acc. to the Martindale method, EN ISO 12947

Flammability EN 1021-1/2 | DIN 4102 B1 | Önorm B1/Q1

NF D 60 013 | NF P 92 507 M1 | UNI 9175 11M

UNI 9177 classe 1 | US Cal. Tech. Bull. 117

IMO A.652 (16)

Fastness to light Note 5-8, ISO 105-B02

Fastness to rubbing (ISO) dry 4-5, wet 4-5

Pilling Note 4, EN ISO 12945



Matrix

kvadrat



Category F

Composition 100% Trevira CS

Weight 760 g/lin.m

Abrasion resistance

App. 60.000 rubs acc. to the Martindale method, EN ISO 12947

Flammability EN 1021-1/2 | BS 5852 crib 5 | BS 5867 part 2 type B

DIN 4102 B1 | Önorm B1/Q1 | NF D 60 013

UNI 9175 11M | US Cal. Tech. Bull. 117 | NFPA 701

IMO A.652 (16)

Fastness to light Note 5-7, ISO 105-B02

Fastness to rubbing (ISO) dry 4-5, wet 4-5

Pilling Note 4, EN ISO 12945



Fixing Systems

Fixing System Wall (included)

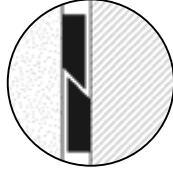
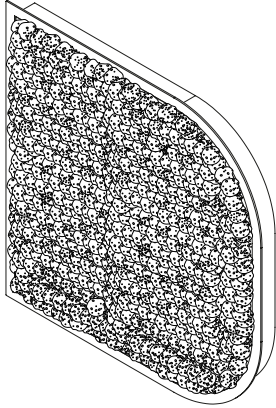

1 pc BuzziMood Round | Square D | Square Leaf
2 pcs Rectangular D | Rectangular | Leaf | Zig | Zag

Can be mounted horizontally or vertically.

Dimensions

BuzziMood Round

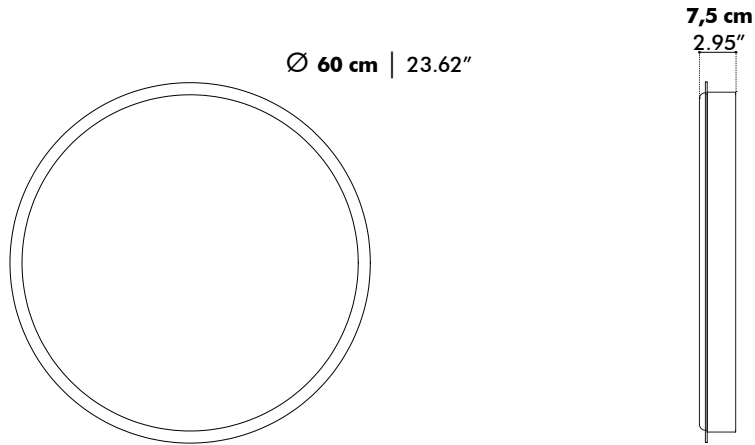

BuzziMood Square D

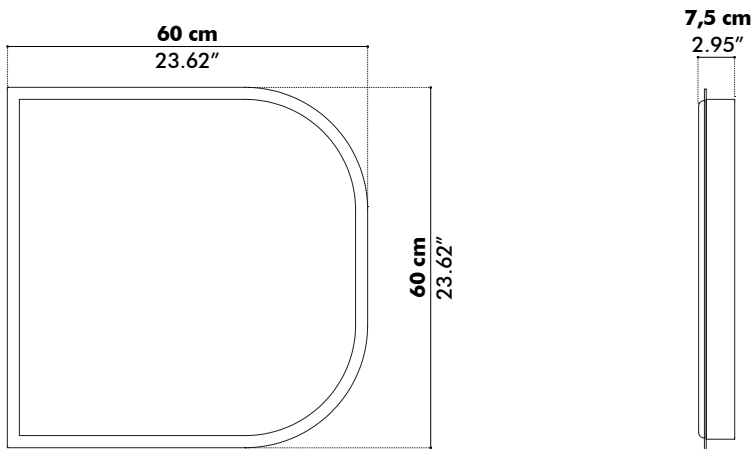

BuzziMood Square Leaf

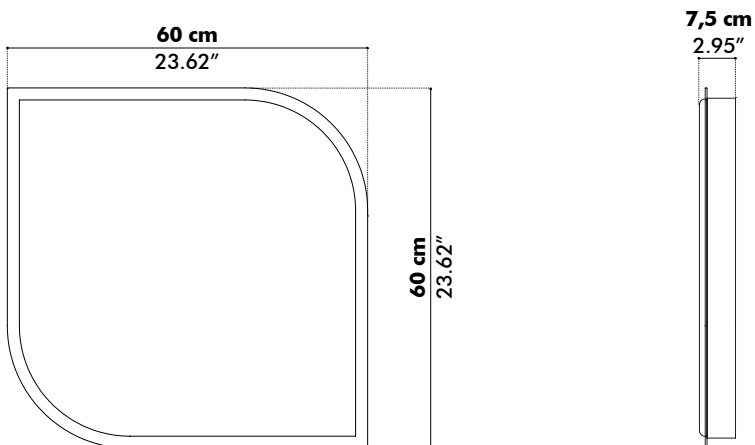

BuzziMood Rectangular D

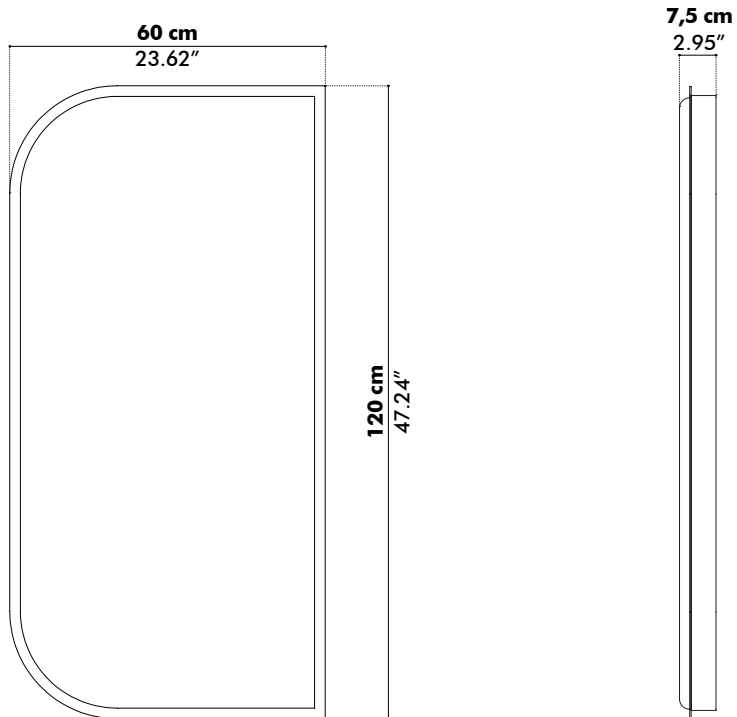

BuzziMood Rectangular Leaf

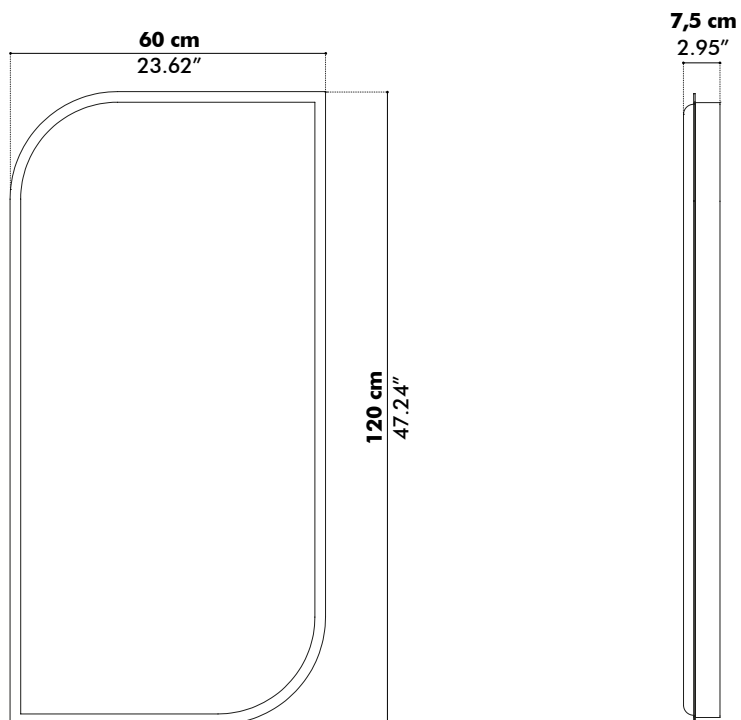

BuzziMood Zig

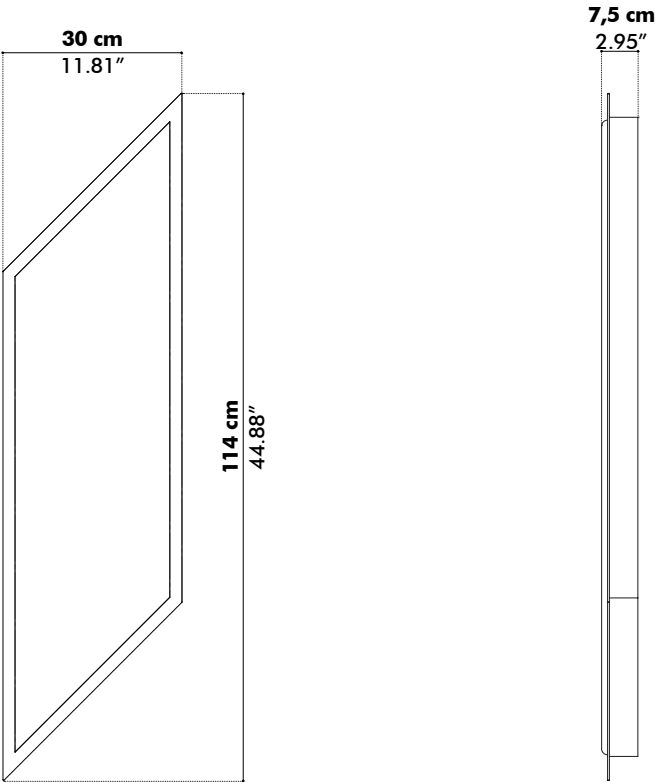

BuzziMood Zag

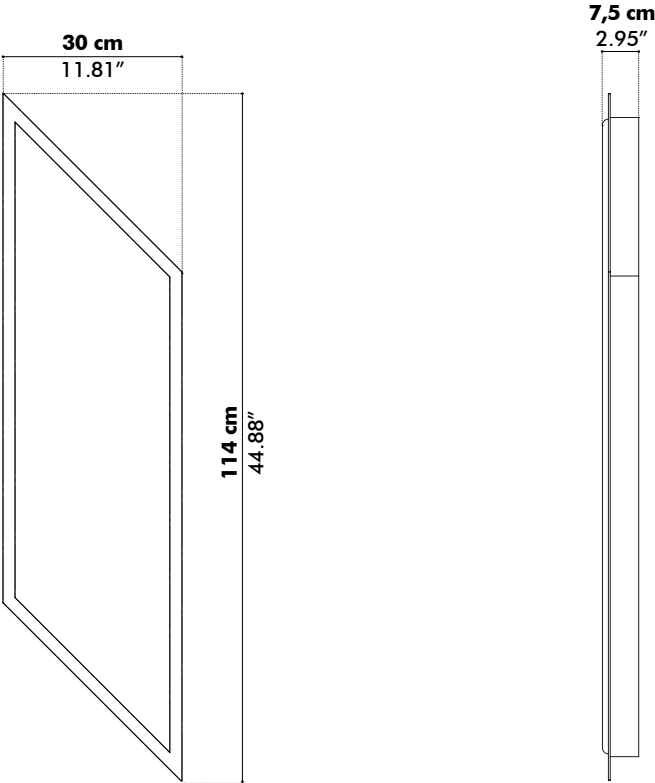

Acoustics

BuzziMood Upholstered

Absorption coefficient

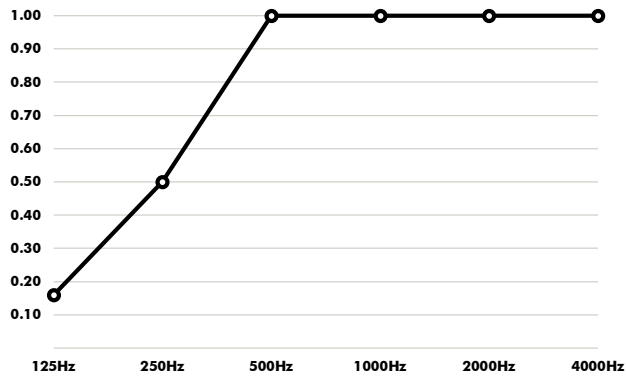

Hz	α^s
125	0.16
250	0.50
500	1
1000	1
2000	1
4000	1

Absorption Values

α_w
(ISO 11654) **0.85**

NRC
(ASTM - C423) **0.90**

SAA
(ASTM-C423) **0.90**

BuzziMood Moss

Absorption coefficient

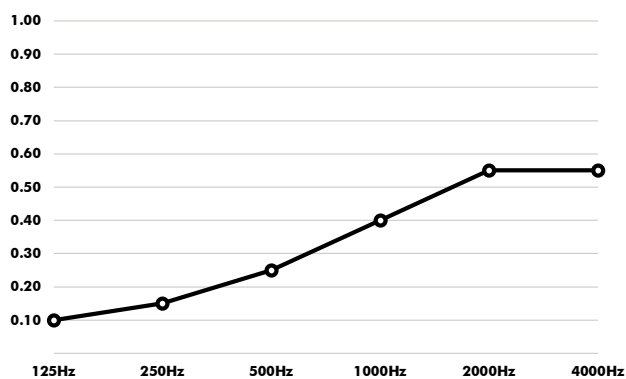

Hz	α^s
125	0.1
250	0.15
500	0.25
1000	0.40
2000	0.55
4000	0.55

Absorption Values

α_w
(ISO 11654) **0.35**

NRC
(ASTM - C423) **0.35**

SAA
(ASTM-C423) **0.35**

Glossary

All calculations are based on accredited lab measurements, official document available on Buzzi.Space

Definitions

α	Weighted absorption coefficient	(ISO 11654)
NRC	Noise reduction coefficient	(ASTM - C423)
SAA	Sound absorption average	(ASTM - C423)

Classification of sound absorbers NEN-EN-ISO 11654

A	0.90 0.95 1.0
B	0.80 0.85
C	0.60 0.65 0.70 0.75
D	0.03 0.55
E	0.15 0.25