

NATIVE UNION / LA BOITE CONCEPT

PR / 01



Sharing values of bringing superior technological performance to everyday products, NATIVE UNION and La Boite concept have teamed up to co-develop a new generation speaker: PR / 01.



/

NATIVE UNION balances design and performance, combining the finest materials with modern craft. Founded in 2009, they create premium tech accessories for the discerning global individual who embraces the modern fluidity between work and play.

/

La Boite concept combines more than 70 years of expert knowledge in audio, following traditional hi-fi with all-in-one audio products that are tailored to their environments and incorporate new sound technologies.



A MASTERPIECE OF SOUND

NATIVE UNION collaborates with audio experts La Boite concept to create a state-of-the-art speaker for the home with advanced connectivity, a beautiful design and unmatched acoustics.



UNDERSTATED AND TIMELESS APPEAL

Made from wood and hard-wearing home textile with brass toned aluminum controls, PR / 01 blends seamlessly into your home environment.





DESIGNED FOR THE FUTURE

PR / 01 features Bluetooth® connection and multiple methods of audio-in (any Wi-Fi module can be added and powered inside its concealed drawer). Designed with USB charging ports, you can charge your devices as you enjoy listening to music.



2 × USB-A



1 × USB-C

WIRELESS CHARGER

The PR/01 has a built-in recess inside its wooden exterior that can discreetly accommodate the NATIVE UNION DROP WIRELESS CHARGER. Place any of your Qi compatible devices on top to charge.



70 YEARS OF EXPERTISE

Led by the R&D teams at La Boite concept, the technology behind PR / 01 is a reinvention of a patent from the 1970's. Initially developed by the Cagniard family, the original patent, Active Pression Reflex*, has been adapted to support new digital technologies.

*Pat. Pending Active Pression Reflex

UNMATCHED SOUND FIDELITY

Active Pression Reflex* technology consists of two speakers inside a multi-amplified pneumatic system.

This exclusive design allows PR / 01 to produce unmatched sound fidelity, even low frequency sounds which is impressive for a speaker of its size.

PR / 01 delivers a powerful and natural sound.
Very close to that of a real orchestra.

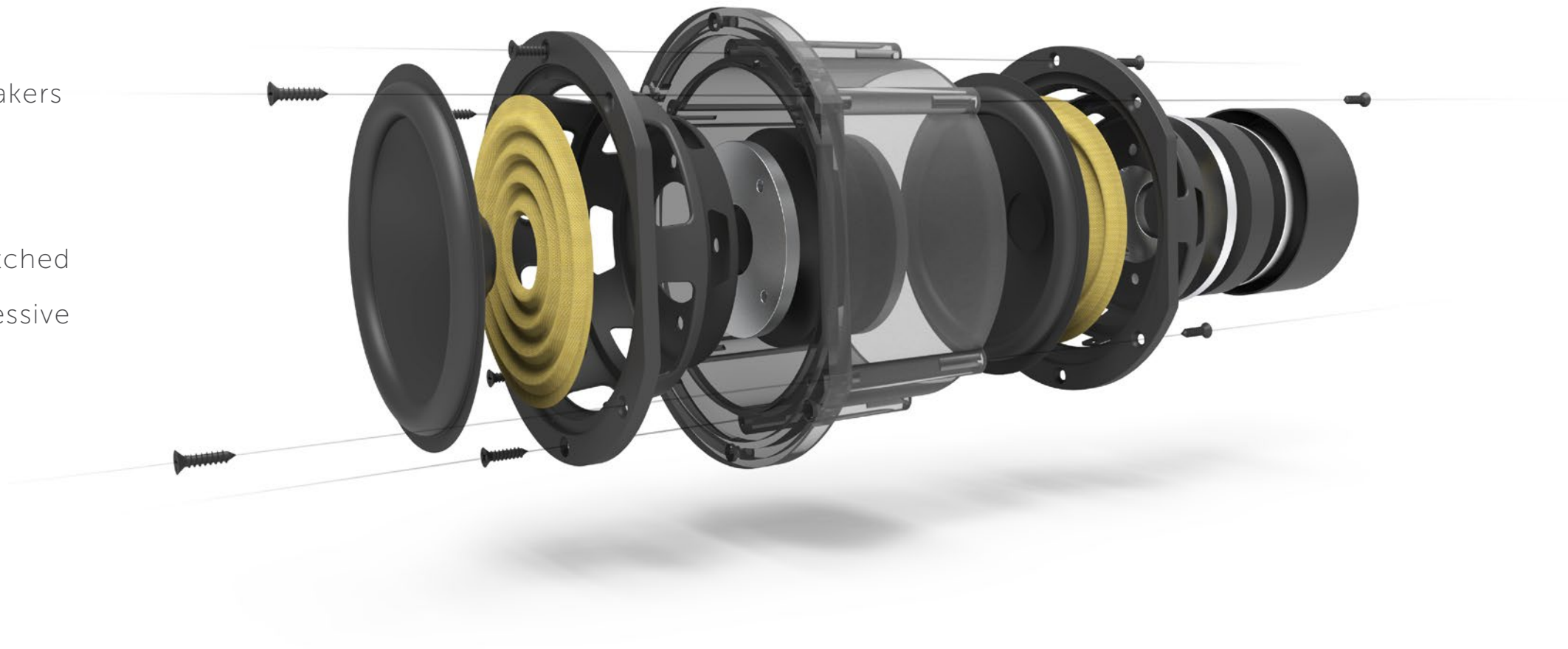

*Pat. Pending Active Pression Reflex

COMPACT SIZE, POWERFUL SOUND



ACTIVE PRESSION REFLEX*

WITH 4 AMPLIFIERS FOR HIGH DEFINITION SOUND EVEN IN EXTREME BASS

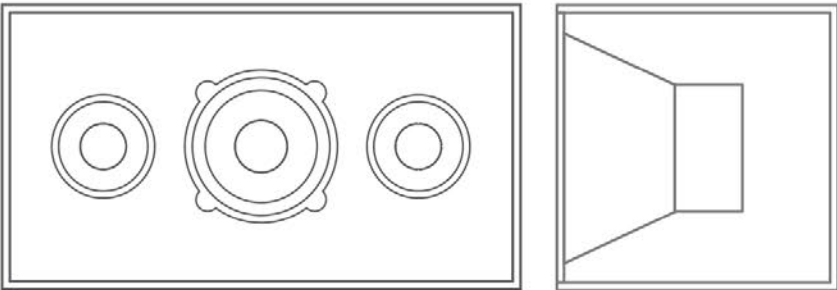

BIG HIFI SYSTEM

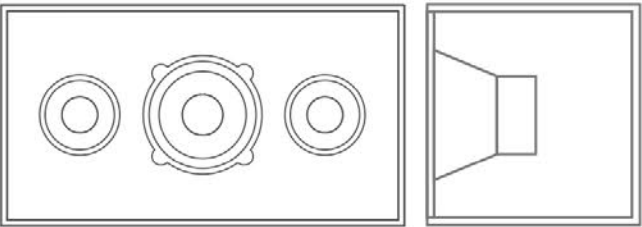
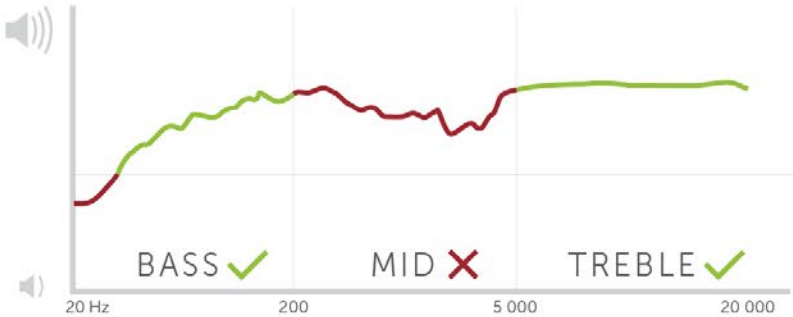

CLASSIC COMPACT SPEAKER

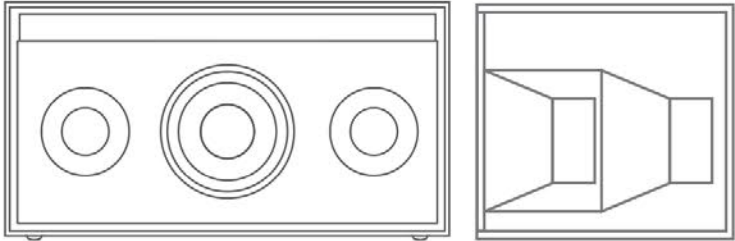
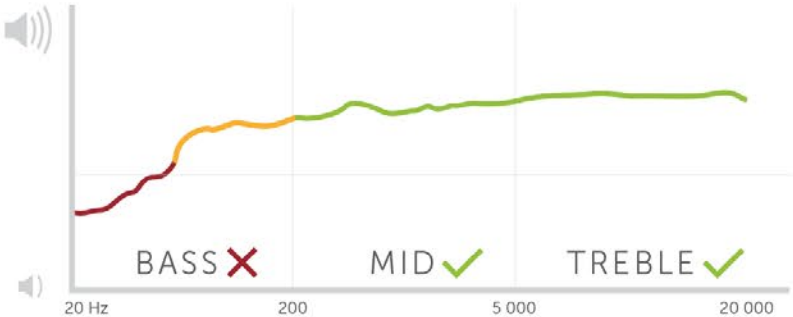

PR / 01 WITH ACTIVE PRESSION REFLEX

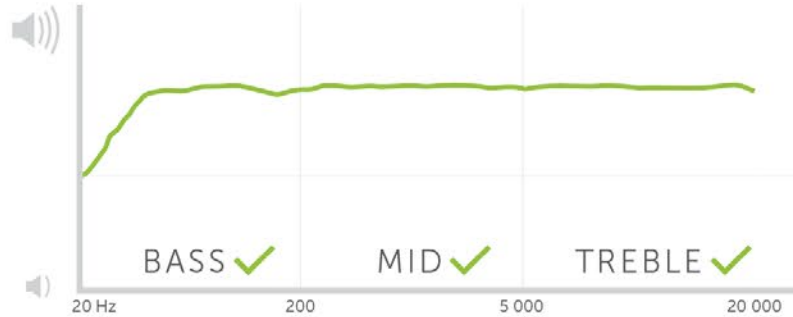

*Pat. Pending Active Pression Reflex



PR/01 UP CLOSE

SOURCES

- Bluetooth® AptX
- DAC Optical: Optical audio digital input
- AUX 1: RCA analog input
- AUX 2: 3.5mm stereo plug

DRIVER UNITS

- 1 x 5" Midrange speaker by LBC
- 1 x 5" long excursion Woofer by LBC
- 2 x Dome silk Tweeter by LBC

USB CHARGER

- 2x USB-A (Always on, charging up to 2.4A)
- 1x USB-C (Always on, charging up to 3A)
- Smart IC, Total output 5V*5.4A=27W

DIMENSIONS & WEIGHT

- H: 237mm L: 410mm D: 256mm
- Weight: 11kg



NATIVE UNION

nativeunion.com

NATIVE UNION is a trademark of Design Pool Limited, registered in Hong Kong and other countries. La Boite concept is a trademark of CC LAB, registered in France and other countries. The Bluetooth® word mark and logos are registered trademarks owned by the Bluetooth® SIG, Inc. and any use of such marks by Design Pool Limited is under license. Other trademarks and trade names are those of their respective owners.